

SIEMENS

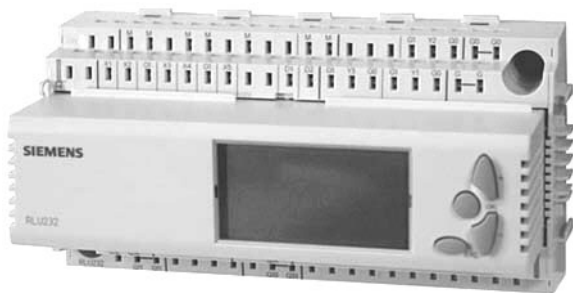

Synco™ 200 Universal Controller RLU2...

Basic Documentation

Edition 1.0

CE1P3101en
07.07.2004

**Siemens Building Technologies
HVAC Products**

Siemens Building Technologies AG
Landis & Staefa Division
Gubelstrasse 22
CH -6301 Zug
Tel. +41 41-724 24 24
Fax +41 41-724 35 22
www.landisstaefa.com

© 2004 Siemens Building Technologies AG
Subject to alteration

Contents

1	Summary	5
1.1	Range of units	5
1.2	Equipment combinations	5
1.3	Product documentation.....	6
1.4	Functions	7
1.5	Important notes.....	8
2	Operation.....	9
2.1	Operating elements and display	9
2.2	Operating and access levels	11
2.3	Menu.....	13
3	Commissioning.....	15
3.1	Safety	15
3.2	Entering commissioning mode	15
3.3	Choosing the basic configuration	16
3.4	Three ways to get the right application.....	17
3.5	Performing a wiring test.....	17
3.6	Leaving commissioning mode	18
4	General settings	19
4.1	Choosing units.....	19
4.2	Device information.....	19
5	Operating modes	20
5.1	Basic types	20
5.2	Room mode selection via digital inputs	20
5.3	Fan release.....	22
6	Inputs.....	23
6.1	Universal inputs X1...X5.....	23
6.2	Analog inputs X1...X5	24
6.3	Digital inputs (D1, D2, X1...X5).....	28
6.4	Absolute remote setpoint (REM)	29
6.5	Relative remote setpoint (REL)	31
6.6	Outside temperature (OUTS)	33
6.7	Room temperature (ROOM).....	34
7	Aggregates.....	35
7.1	Pump (PUMP x).....	35
7.2	Modulating output (AO x).....	38
7.3	Heat recovery equipment/mixed air damper (HREC)	40
7.4	Variable step switch (STEP Vx).....	49
7.5	Linear step switch (STEPLIN)	52

7.6	Binary step switch (STEPBIN)	56
7.7	3-position output (3-POINT).....	60
8	Controller (CTLOOP x)	62
8.1	General	62
8.2	Control strategies and setpoints	63
8.3	Room temperature control	65
8.4	Room/supply air temperature cascade controller.....	66
8.5	Supply air temperature control.....	70
8.6	Universal controller	72
8.7	Primary controller (universal) with changeover.....	75
8.8	Sequence controllers, output assignments	79
8.9	Limit control, general (LIM)	84
8.10	Limit control of individual sequences (SEQ)	86
8.11	Locking of sequences according to outside temperature.....	89
8.12	Summer/winter compensation.....	90
8.13	Universal setpoint shift.....	91
8.14	Deviation message (DV ALM).....	93
9	Frost protection (FROST).....	95
9.1	Purpose and types of monitoring	95
9.2	Activating the function block	95
9.3	Settings	96
9.4	Operating principle.....	96
9.5	Acknowledgement / reset (AKN).....	99
9.6	Display indication	99
9.7	Connection diagrams	100
9.8	Error handling	101
9.9	Settings	101
10	Dealing with alarms	102
10.1	Alarm list	102
10.2	Troubleshooting	103
11	Electrical connections.....	104
11.1	Connection rules	104
11.2	Connection terminals	105
12	Appendix.....	106
12.1	Abbreviations used	106
12.2	Synco 200 operating texts	107
12.3	Configuration.....	111
13	Application examples	124

1 Summary

1.1 Range of units

Controller types and accessories

The following table lists the controller types and accessories belonging to the product range, and indicates the respective datasheets:

<i>Device</i>	<i>Name</i>	<i>Type</i>	<i>Data Sheet no.</i>
Controllers	Universal controller	RLU210	N3101
	Universal controller	RLU222	N3101
	Universal controller	RLU232	N3101
	Universal controller	RLU236	N3101
Service unit	Service tool	OCI700.1	N5655
Installation accessories	Front panel mounting frame	ARG62.201	N3101

Housing variants

The following pictures show the controller versions with large and small housing variants:

RLU232 and RLU236

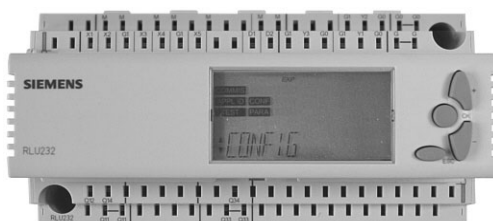

RLU210 and RLU222

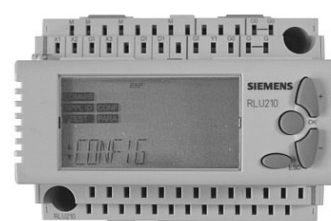

1.2 Equipment combinations

Possible combinations

The following table lists the equipment that is combinable with the above controllers:

<i>Device</i>	<i>Type</i>	<i>Datasheet no.</i>
Passive sensors	All types of sensors using a sensing element LG-Ni 1000, Pt 1000 or T1 (PTC)	N1721...N1846, N1713
Active sensors	All types of sensors with Operating voltage AC 24 V Modulating DC 0...10 V output signal	N1821, N1850...N1932
Monitors	QAF81..., QAF64..., QFA81, QFM81, QFX21, QXA2000, QBM81...	N1284, N1283, N1513, N1514, N1541, N1542 N1552
Signal converter	SEZ220	N5146
Room units	QAA25, QAA27	N1721
Passive signal sources	BSG21.1, BSG21.5, QAA25, QAA27	N1991, N1721
Active signal sources	BSG61	N1992
Actuating devices	All types of electromotoric and electrohydraulic actuators: operating on AC 24 V for modulating control DC 0..10 V For detailed information on actuators and valves, refer to:	N4000...N4999

1.3 Product documentation

Supplementary information

In addition to this Basic Documentation, the product documents listed below provide detailed information on the safe and correct deployment and operation of Synco™ 200 products in building services systems.

<i>Type of document</i>	<i>Ordering number</i>
Basic Documentation "Universal Controllers RLU2..."	CE1P3101en
Application Datasheets "Universal Controllers RLU2..."	CE1A3101en
Datasheet "Universal Controllers RLU2..."	CE1N3101en
Installation Guide for Universal Controllers RLU2...	CE1G3101x1
Operating Instructions for Universal Controllers RLU2...	CE1B3101x1
Declaration of CE Conformity, Synco 200	CE1T3101xx
Environmental Declaration for Universal Controllers RLU210, RLU222	CE1E3101en01
Environmental Declaration for Universal Controllers RLU232, RLU236	CE1E3101en02

1.4 Functions

Overview

The following table provides an overview of the functions available with the various controller types:

<i>Function</i>	<i>RLU210</i>	<i>RLU222</i>	<i>RLU232</i>	<i>RLU236</i>
Number of preloaded applications	19	40	21	27
Basic types				
Basic type A	✓	✓	✓	✓
Basic type U	✓	✓	✓	✓
Selection of operation				
ON/OFF via digital inputs	✓	✓	✓	✓
Mode selection via digital inputs	✓	✓	✓	✓
Changeover	✓ (A, U)	✓ (U)	✓ (U)	✓ (U)
Interaction with heating controller	✓	✓	✓	✓
Alarms				
Indicating relay, frost and primary controlled variable	0	✓	✓	✓
Indicating relay, deviation indication	0	✓	✓	✓
Digital inputs	1	1	2	2
Universal inputs	3	4	5	5
Analog inputs DC 0...10 V	✓	✓	✓	✓
Analog inputs LG-Ni 1000	✓	✓	✓	✓
Analog inputs T1	✓	✓	✓	✓
Analog inputs PT 1000	✓	✓	✓	✓
Digital inputs	✓	✓	✓	✓
Remote setpoints (absolute and relative)	✓	✓	✓	✓
Modulating outputs DC 0...10 V	1	2	3	3
Relay outputs	0	2	2	6
Pump	0	2	2	3
Analog output	1	2	3	3
Heat recovery unit / damper	1	1	1	1
Variable step switch (1-6 steps)	0	0	0	1
Variable step switch (1-2 steps)	0	1	1	1
Linear step switch (1-6 steps)	0	0	0	1
Linear step switch (1-2 steps)	0	0	1	0
Binary step switch (1-4 steps)	0	0	0	1
Binary step switch (1-2 steps)	0	0	1	0
3-position output	0	1	0	0
Universal controller \ \ //	0	1	1	1
Universal controller \ /	1	0	1	1
Room / supply air cascade controller	1	1	1	1
Remote setpoint adjuster	1	1	1	1
Setpoint shift via room unit	1	1	1	1
Setpoint shift based on outside temperature	1	1	1	1
Universal setpoint shift	1	1	1	1
Limit control, general	1	1	1	1
Limit control of individual sequences	1	1	1	1
Locking of sequences	2	4	6	6
Frost protection				
Frost protection unit	✓	✓	✓	✓
2-stage frost protection on the air side	✓	✓	✓	✓
2-stage frost protection on the water side	✓	✓	✓	✓
Fan enable RELEASE	0	1	1	1

1.5 Important notes



This symbol draws your attention to special safety notes and warnings. If such notes are not observed, personal injury and / or considerable damage to property can occur.

Field of use	Synco™ 200 products may only be used for the control and supervision of heating, ventilation, air conditioning and chilled water plant.
Correct use	Prerequisites for flawless and safe operation of Synco™ 200 products are proper transport, installation, commissioning, and correct operation.
Electrical installation	Fuses, switches, wiring and earthing must be in compliance with local safety regulations for electrical installations.
Commissioning	Preparation for use and commissioning of Synco™ 200 products must be undertaken by qualified staff who have been appropriately trained by Siemens Building Technologies.
Operation	Synco™ 200 products may only be operated by staff who have been instructed by Siemens Building Technologies or their delegates and whose attention has been drawn to potential risks.
Wiring	When wiring the system, the AC 230 V section must be strictly segregated from the AC 24 V safety extra low-voltage (SELV) section in order to ensure protection against electric shock hazard!
Storage and transport	<p>For storage and transport, the limits given in the relevant datasheets must always be observed.</p> <p>If in doubt, contact your supplier or Siemens Building Technologies.</p>
Maintenance	Synco™ 200 products are maintenance-free, apart from cleaning at regular intervals. System sections accommodated in the control panel should be freed from dust and dirt whenever normal service visits are due.
faults	<p>If system faults occur and you are not authorized to perform diagnostics and rectify faults, call your Siemens Building Technologies service representative.</p> <p> Only authorized staff are permitted to perform diagnostics, to rectify faults and to restart the plant. This also applies to work carried out within the control panel (e.g. safety checks or changing fuses).</p>
Disposal	<p>The products contain electrical and electronic components and may not be disposed of as household waste.</p> <p>Current local legislation must be observed.</p>

2 Operation

2.1 Operating elements and display

2.1.1 Operating elements

Picture

The following picture shows the operating elements of the RLU2... universal controllers:

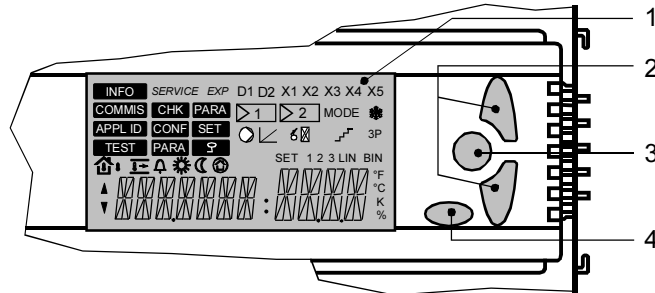

Legend

Pos.	Name	Properties / function
1	Display	Segmented display, backlit
2	"+" and "-" buttons	For navigation and value adjustment
3	"OK" button	For acknowledgement during navigation and value input
4	"ESC" button	To return to the previous menu or cancel value input

2.1.2 Display

Picture / segmentation

The display is divided into functional groups. Each shows icons representing defined states. Collectively they present current information for the user.

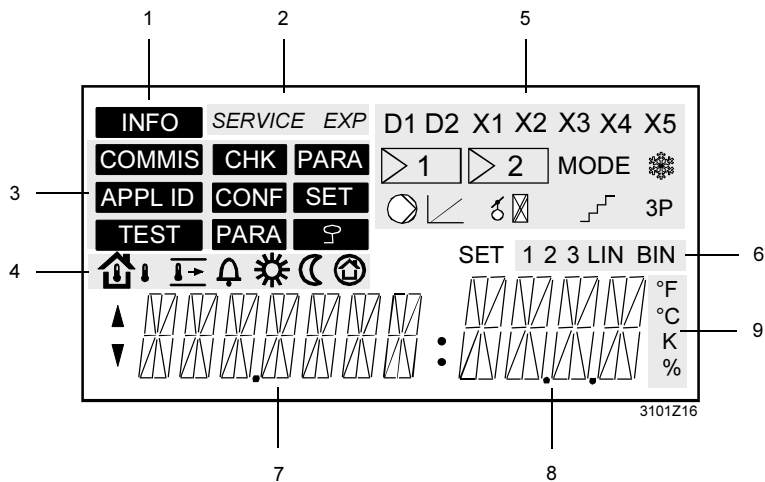























Legend

Item	Name
1	Information page display
2	Access levels display
3	Menu navigation
4	Display for measured variables, operating modes
5	Function block navigation: display corresponds to configuration diagram
6	Function block instances
7	Information segments (7 characters): data point description (mnemonic)
8	Value segments (4 characters): displays data point values
9	Units display

2.1.3 Display icons

Table of icons used

The following table shows the icons used on the display with their meanings. They are grouped according to the segmentation shown in the above.

<i>Icon</i>	<i>Meaning</i>	<i>Icon</i>	<i>Meaning</i>
Operating level		Function block navigation	
	Information level	D1, D2	Digital input D1, D2
None	Setting level	X1...X5	Analog input X1...X5
Access level			Controller 1 (or controller 2)
<i>SERVICE</i>	Service level	MODE	Operating mode
<i>EXP</i>	Password level		Frost protection FB
Menus			Pump FB
	Commissioning		Analog output FB
	Basic type		Heat recovery FB
	Wiring test		Step switch FB
	Inputs / outputs	3P	3-position output FB
	Configuration	Instances	
	Parameter settings	1	Instance 1
	Setpoints, adjustable	2	Instance 2
Measured variables, operating modes		3	Instance 3
	Outside temperature	LIN	Linear step switch
	Room temperature	BIN	Binary step switch
	Supply air temperature	Units	
	Fault	F	Degrees Fahrenheit
	Room operating mode "Comfort"	°C	Degrees Celsius
	Room operating mode "Economy"	K	Kelvin
	Protection mode	%	Percent
Navigation		Miscellaneous	
	Navigation UP or value +	SET	Adjustable value
	Navigation DOWN or value –		

Note on access levels

The user level is activated if neither the icon for the service level nor the icon for the password level is visible.

2.2 Operating and access levels

2.2.1 Operating levels

Two operating levels

RLU2... universal controllers have two basic operating levels. They are called:

- Information level
- Main menu

Their properties and identifiers are listed in the following.

Name	Properties	ID
Information level	This level displays important plant data in the form of information.	INFO
Main menu	This level has the structure of a menu tree. It provides for reading and adjustment of data points.	None

Note

These 2 levels are always available regardless of which access level is active.

The term "data point" in Synco 200

In Synco 200, the term "data point" is used as a generic term that includes:

- Real data points with a physical connection to the mechanical and electrical systems, and
- Virtual data points with no direct connection to the mechanical and electrical systems (e.g. defined in the software only, e.g. setpoints).

The setting and reading values of all data points are configured as operating lines in the menu structure. The operating elements make it possible to select and read or adjust (setting parameters) any data point.

All menus are represented by mnemonics on the LCD display.

Switching between the two operating levels

You can switch between the two operating levels in the following way:

- From information level to main menu: Press the "OK" button
- From main menu to information level: Press the "ESC" button

Information page and main menu examples

This example illustrates the above statements. The two views shown are the information page for the user (upper) and a page from the main menu (lower):

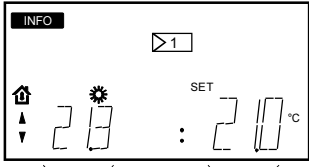
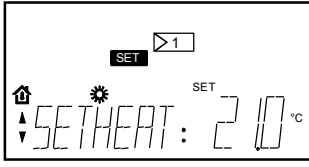
Display	Explanations
 <p>Present value Present setpoint</p>	<p>Information level:</p> <ul style="list-style-type: none"> • The navigation buttons " + " / " - " switch the display between the various information pages. • The number and appearance of the information pages depends on the selected application.
	<p>Main menu:</p> <ul style="list-style-type: none"> • The navigation buttons switch the display between the various data points, e.g. to the SETHEAT setpoint in this example. • To change values: <ol style="list-style-type: none"> 1. Press the "OK" button. 2. Use the navigation buttons to change the value, e.g. to 21.0 °C in this example. 3. Press the "OK" button => the new value is applied.

2.2.2 Access levels

The three access levels

RLU2... universal controllers have three access levels. They are called:

- User level
- Service level
- Password level

One of these access levels is associated with each data point.

Access

The following table lists the three access levels with their respective purpose, accessibility and icon:

<i>Level</i>	<i>Access</i>	<i>Icon</i>
User level (for the plant operator)	The user level is always accessible. Users can modify all data points that are visible/adjustable at this level.	None
Service level (for maintenance)	<ol style="list-style-type: none">1. Simultaneously press the "OK" and "ESC" buttons.2. Use the " + " / " - " buttons to choose the service level SERV.3. Press the "OK" button to confirm your choice.	<i>SERVICE</i>
Password level (for commissioning)	<ol style="list-style-type: none">1. Simultaneously press the "OK" and "ESC" buttons.2. Use the " + " / " - " buttons to choose the password level EXP.3. Press the "OK" button to confirm your choice.4. When PASSWRD is displayed, select the figure 2 using the " + " button.5. Press the "OK" button to confirm your choice.	<i>EXP</i>

Common properties

The three access levels have the following properties in common:

- The access level determines which individual menus and operating lines are enabled.
- At a higher access level, all of the menus and operating lines of the lower access levels remain visible.
- The levels are all based on a common menu tree. The entire menu tree is available at password level.
- The controller returns to the user level after a 30-minute timeout. Timeout: period without user input at the controller.

2.3 Menu

2.3.1 Menu structure

Levels and menus

The controller shows or hides the respective submenus according to the selected access level:

<i>User level</i>	<i>Service level</i>	<i>Password level</i>
Information level Info displays 1...n ↓ OK ESC ↑	Information level Info displays 1...n ↓ OK ESC ↑	Information level Info displays 1...n ↓ OK ESC ↑
Main menu SET (setpoints)	Main menu CHK (inputs / outputs) PARA (settings) SET (setpoints)	Main menu COMMIS (commissioning) APPL ID (basic configuration) CONF (extra configuration) TEST (wiring test) PARA (settings) CHK (inputs / outputs) PARA (settings) SET (setpoints)

Notes on the user level

At the user level, the "OK" button switches the menu directly to the **SET** (setpoint) list, where you can use the " + " (UP) and " - " (DOWN) buttons to choose and adjust a setpoint.

2.3.2 Menu navigation

Example

The following pictures demonstrate menu navigation with the example of adjusting proportional band Xp for sequence 1 of control loop 1. The access level is already set to *SERVICE*.

Starting point: Information level

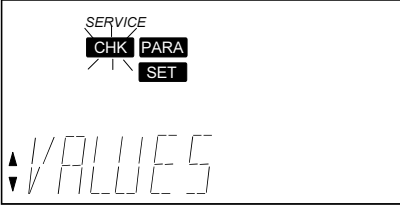
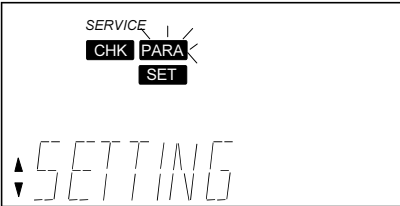
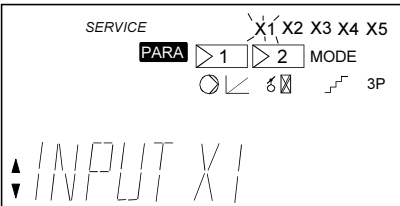
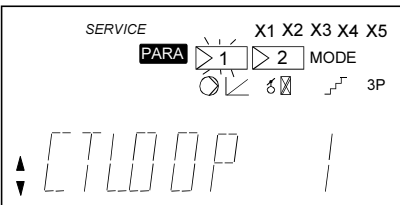
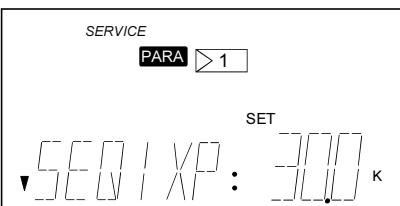
Step	Display	Procedure / results
1		<p>1. Press the "OK" button: => the first menu item starts to flash, in this case CHK (inputs / outputs)</p> <p><i>Note:</i> The information segments present explanatory texts about the menu (here: <i>VALUES</i>).</p>
2		<p>1. Use the "-" button to navigate to the PARA (settings) menu item: => PARA starts to flash.</p> <p>2. Confirm your choice with the "OK" button.</p>
3		<p>The controller displays the function block selection with the first function block (X1) flashing.</p>
4		<p>1. Use the "-" button to navigate to the CTLOOP 1 menu item.</p> <p>2. Confirm your choice with the "OK" button.</p>
5		<p>The controller displays the parameter selection (see information segments, bottom left).</p> <p>1. Use the "+" / "-" buttons to navigate to the parameter of your choice (SEQ1 XP), then press the "OK" button: => the corresponding value starts to flash (30.0)</p> <p>2. Use the "+" / "-" buttons to adjust the value, and confirm the new value with the "OK" button.</p>

3 Commissioning

3.1 Safety



Preparation for use and commissioning of Synco™ 200 controllers must only be undertaken by qualified staff who have been appropriately trained by Siemens Building Technologies.

3.2 Entering commissioning mode

3.2.1 Entry on first startup

Procedure

The controller automatically enters the commissioning menu when the AC 24 V power supply is applied. Please note the following:



- The control process remains deactivated in the commissioning mode – all outputs are set to a defined OFF state on controller power-up.
- All of the controller's internal safety features are also deactivated!

Factory settings

The controller displays these settings as soon as it is powered up:

- **EXP** access level (password level)
- **COMMIS** (commissioning) menu with the **APPL ID** (basic configuration) submenu flashing.

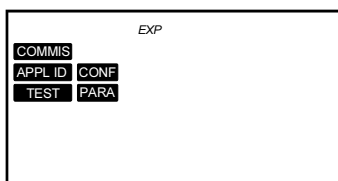

3.2.2 Entry from the main menu

Prerequisite

The **COMMIS** (commissioning) menu is only active at password level (password = 2). If the password level is not already selected, simultaneously press the "ESC" and "OK" buttons activate it.

Plant is stopped

When a user enters the commissioning menu from the main menu, the controller indicates that the plant will be stopped:

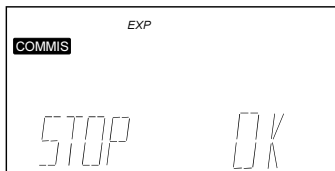

Pressing the "OK" button produces the following results:



- The controller stops the plant and deactivates the control process.
- It sets all outputs to a defined OFF state.
- It also deactivates all of the controller's internal safety features!
- The controller displays the submenus of the **COMMIS** (commissioning) menu with the first one, **APPL ID** (basic configuration), flashing; refer to the picture under "factory settings" in the above.

3.3 Choosing the basic configuration

APPL ID (basic configuration) menu

The **APPL ID** (basic configuration) menu permits the following settings:

- Choice of basic type A or U
- Choice of programmed application

3.3.1 Choosing the basic type

Distinction between basic types A and U

The basic type is the first thing you must set in every device. The choice of basic type enables and disables certain functions. We distinguish between the following basic types:

Basic type A	Basic type U
Deployment as a room controller	Deployment as a universal controller
Key feature: Controller 1 is a room temperature controller, supply air temperature controller, or room/supply air temperature cascade controller	Key feature: Controller 1 is a universal controller

3.3.2 Choosing a programmed application

Selection

Each device contains tested, programmed applications.

The simplest commissioning method is to activate one of the programmed applications.

The programmed applications are described in the Application Catalog and in the "Synco Select" tool.

Selection example

The APPL ID line displays the following: A01

Meanings:

A This standard application corresponds to basic type A.

01 First number of the internally loaded standard application

Notes

Empty applications are displayed with A and U.

Additionally, there is a data point in the **CHK** menu that indicates whether the programmed application has been modified (ADAP = adapted) or not (ORIG = original).

3.3.3 Settings

Configuration

Path: ... > **COMMIS** > **APPL ID**

Display	Name	Range / remark
APPL ID	Basic type	Basic type setting: A, U, A01, A02, A03, A04, ..., U01, U02, ...

Display value

Path: **CHK**

Display	Name	Remark
APPL ID	Basic type	Original (ORIG) Adapted (ADAP)
APPL ID	Basic type	Basic type indication

3.4 Three ways to get the right application

3.4.1 Programmed application

The simplest way

Each universal controller contains a large number of tested, programmed applications. The simplest commissioning method is to activate one of the programmed applications and, if necessary, adjust the parameters to reflect the actual plant. The programmed applications are described in the Application Catalog or in the "Synco Select" tool.

3.4.2 Adapted application

The happy medium

The programmed application doesn't quite fit, but an adapted application is described in the Application Catalog. Make the appropriate settings in the **CONF** (extra configuration) menu in order to adapt the application.

3.4.3 Free configuration

The most costly way

The application you want is not described; you have to set up the configuration from scratch. You can adapt the controller to the plant using the configuration diagrams (see chapter 12.3, Configuration).

3.5 Performing a wiring test

Functions

When the peripheral equipment is connected, you can perform a wiring test in the **TEST** (wiring test) menu. We recommend performing the test after completion of the configuration and settings. It provides the following functions:

- Indication of input reading values
- ON/OFF switching of the aggregates connected to the outputs, such as pumps
- Specification of a 0...100 % signal for step switches, where the relay is switched



The application is deactivated during the wiring test. The outputs are in a defined "OFF" state, and safety-related functions (e.g. frost protection) are deactivated!

Error checks

The wiring test provides checks for the following errors at the inputs and outputs:

- Connection errors, i.e. reversed wires
- Position errors, i.e. sensors or actuators connected in the wrong place
- Discrepancies between connection method and controller configuration, LG-Ni 1000 instead of active DC 0...10 V

3.6 Leaving commissioning mode

User information

When you leave the **COMMIS** (commissioning) menu by pressing the **ESC** button, the controller displays the following information to indicate that the plant will be started:

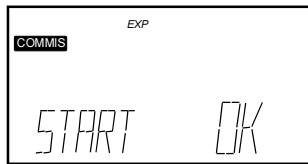

Plant starts

Pressing the "OK" button produces the following results:

- The application starts,
 - the controller checks all sensors, and
 - it tags the existing sensors for later fault messages
- The display switches to the next-higher menu level, and the **COMMIS** menu icon starts to flash:



Exit

Now press the "ESC" button twice.

The controller will display an information page like the following if it is in normal mode:

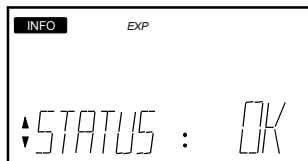

4 General settings

4.1 Choosing units

Setting values

At the service and password levels, you can switch the temperature unit between °C/K and °F:

Path: ... > **PARA** > **MODE**

<i>Display</i>	<i>Name</i>	<i>Range</i>	<i>Factory setting</i>
UNIT	Unit	°C, °F	°C

4.2 Device information

Display values

You can view the SW version at the service and password levels:

Path: **CHK**

<i>Display</i>	<i>Name</i>	<i>Remarks</i>
SW-VERS	Software version	

5 Operating modes

5.1 Basic types

Basic applications



We distinguish between the following two basic applications in the RLU2.. universal controllers:

- Basic type A => controller 1 is a room temperature controller
- Basic type U => controller 1 is a universal controller

Operating modes

In normal operation, the operating mode for basic types A and U is preselectable via digital inputs D1 / D2 (e.g. by an external scheduler or manual switch).

There are the following three operating modes:

- Comfort 
- Economy 
- Protection 

5.2 Room mode selection via digital inputs

Operating principle





This feature provides for intervention in the current program without having to make any changes at the controller itself. In order to activate this function, you have to configure the appropriate digital inputs.





Note

Mode switching via HMI (operation) is not possible.

RLU232 and RLU236

The following settings are required depending on the desired function:

Function	Setting	Value
Switch between  comfort /  protection	Digital input D1, hard wired	Permanently configured
Switch between  comfort /  economy	Digital input D2, hard wired	Permanently configured

D1	D2	Operating mode	Function
0	0	 Comfort	"Comfort" is the operating mode for the occupied room. The room state is within the comfort envelope in terms of temperature, humidity, etc.
0	1	 Economy	"Economy" is an energy-saving operating mode for the room if "comfort" mode is not required for a given period. In "economy" mode, the control process operates with setpoints that may differ from the "comfort" mode setpoints. Switchover to "economy" mode is usually done via an external scheduler.
1	0	 Protection	"Protection" is an operating mode in which a plant is only started to ensure that the building and equipment are protected against frost.
1	1	 Protection	See above

Notes

- If there is no wire connected to digital input D1, then D1 = 0.
- If digital input D1 is set to protection, "comfort" / "economy" switchover is deactivated.

RLU210 and RLU222

The following settings are required depending on the desired function:

Function	Setting	Value
Switch between	Digital input D1, hard wired	Permanently

☀ comfort / 🛡 protection		configured
Switch between ☀ comfort / 🏠 economy	Digital input configured for OPMODE	X1...X5

D1	OP MODE	Operating mode	Function
0	0	☀ Comfort	See "RLU232 and RLU236"
0	1	🏠 Economy	See "RLU232 and RLU236"
1	0	🛡 Protection	See "RLU232 and RLU236"
1	1	🛡 Protection	See "RLU232 and RLU236"

Note

If no other digital input is configured as OPMODE (preselected optg mode input), you can configure the switchover between "comfort" / "protection" (default) or "comfort" / "economy" with the hard wired D1 input via parameter settings as an additional function.

Error handling

Errors in operation:

The digital signals cannot be monitored. The controller interprets missing inputs as if the physical input is not connected.

We recommend configuring the control inputs to be open in the normal position (NORMPOS = OPEN).

Configuration errors:

Applying analog signals (e.g. DC 0 ... 10 V or LG-Ni 1000) to the digital control inputs produces an incorrect response that is not monitored.

Application example

You can use the digital inputs to switch a plant to "OFF". However, all safety-related functions remain active.

5.3 Fan release

Function and conditions

This function uses the RLU2... controller's Q1 switch output to enable the fan.

The fan is always enabled if:

- There is no "FROST" signal
- There is no "MAINALM" fault on the main control variable
- The **COMMIS** (commissioning) menu is not active at the controller

Recommendation

Use the switch output as a changeover switch, where:

- Switch output de-energized => fault signal (frost or main control variable error)
- Switch output energized => fan enabled

Connection diagram

The following example shows the connection on an RLU232 unit:

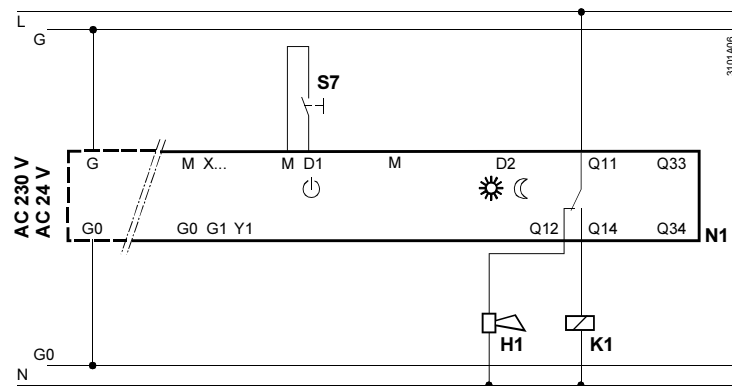

Legend

Q11, Q12, Q14: Terminals of switch output Q1
 K1: Fan relay
 H1: Alarm indicator

Activating the function

To activate the fan release function, assign relay Q1 to the appropriate output signal under **RELEASE** (fan release relay) in the **MODE** submenu.

5.3.1 Settings

Configuration

Path: ... > **COMMIS** > **CONF** > **MODE**

Display	Name	Range / remark
RELEASE	Fan release relay	Activates the relay output; adjustable values: ---, Q1, Q2, ... (free outputs only)

Display values

Path: **CHK**

Display	Name	Remarks
RELEASE	Fan release relay	YES = fan enabled (relay energized) NO = alarm (relay de-energized)

Wiring test

Path: ... > **COMMIS** > **TEST**

Display	Name	Positions
RELEASE	Fan release relay	YES = fan enabled (relay energized) NO = alarm (relay de-energized)

6 Inputs

6.1 Universal inputs X1...X5

6.1.1 General settings

Connectable signals

The following signals can be connected to universal inputs X1...X5:

- Digital signals
- Passive analog signals
- Active analog signals

Number of universal inputs

Depending on the type of RLU2... universal controller, the following number of universal inputs (Xx) are available:

<i>Device type</i>	<i>Number of universal inputs Xx</i>
RLU210	3
RLU222	4
RLU232	5
RLU236	5

6.1.2 Activating the function

Availability

The universal inputs Xx are always available. If they are not required for their assigned functionality, they can be used for diagnostics.

Assigning identifiers

Each input that you use must have a LABEL (input identifier) assigned to it in order to activate it. This identifier also defines the input signal's physical unit. The following identifiers are available:

<i>LABEL (input identifier)</i>	<i>Explanations</i>
ROOM	Room temperature
OUTS	Outside temperature
TEMP	Temperature sensor without dedicated functionality in °C / °F
%	DC 0...10 V signal, unit %
0.0	Universal input with 1 decimal place, resolution -99.9...+999.9, adjustment step 0.1
0000	Universal input 0000
REMX	Absolute setpoint adjuster
REL	Relative setpoint adjuster (rem setp adjuster relative), in K / °F, range -3...+3 K
FRST	Frost protection
DIG	Digital input

Notes on units

There are two special features with regard to the assignment of physical units:

- The unit of room temperature and outside temperature is always °C (°F).
- Digital inputs do not require units.

Further details

There is a more detailed description for each specific use of the universal inputs in the following chapters:

- Universal inputs used as analog inputs, see 6.2
- Universal inputs used as digital inputs, see 6.3

6.2 Analog inputs X1...X5

6.2.1 Activation and type

Activation

To activate the analog inputs X1...X5, follow the procedure described under "activating the function" in the above.

Type (TYPE)

If the unit is °C / °F, the type is selectable. The following types are available:

- NI (LG-Ni 1000)
- 2XNI (2 x LG-Ni 1000)
- T1 (T1)
- PT (Pt 1000)
- 0-10 (DC 0...10 V)

If the unit is not °C / °F, the type is always DC 0...10 V.

6.2.2 Measuring range (MIN VAL, MAX VAL)

Passive temperature signals

The following measuring ranges are defined for passive temperature signals:

<i>Temperature signal</i>	<i>Measuring range</i>
LG-Ni 1000	-50...+250 °C (fixed)
2 x LG-Ni 1000 or T1	-50...+150 °C (fixed)
Pt 1000	-50...+400 °C (fixed)

Active signals

In the case of active signals, the measuring range is definable. Both an upper and a lower measured value is required.

Active DC 0...10 V temperature signals have a default measuring range of 0...200 °C, but they are adjustable within the overall range of -50...+500 °C.

Example

Room temperature with an active signal of DC 0...10 V = 0...50 °C:

- Lower measured value (MIN VAL): 0 °C
- Upper measured value (MAX VAL): 50 °C

6.2.3 Active measured value signal (SIGNALY)

Multiple sensor use

The controller can also signalize measured values from passive sensors in the form of active, modulating signals. In order to achieve this, you must assign an output to the input signal. The settings under "measuring range" are also used for setting up the output.

Example

You want to signalize the measured value from an LG-Ni 1000 sensor as an active signal of DC 0...10 V = 0...50 °C:

- Lower measured value (MIN VAL): 0 °C
- Upper measured value (MAX VAL): 50 °C

Note

The active measuring signal is only usable for analog values.

Digital signals would produce an output of either DC 0 V or DC 10 V.

6.2.4 Correction (CORR)

Resistance compensation

A measured value correction is definable for passive temperature sensors in order to compensate for cable resistance. Therefore, you can perform calibration on site with a reference measuring device.

6.2.5 Special analog inputs

Special functions

Certain sensors are required for special functions, such as pump ON at low outside temperatures. Therefore, the following analog inputs provide additional, special functions:

- OUTS outside temperature; see chapter 6.6
- ROOM room temperature; see chapter 6.7

Special setting values

The following analog inputs provide special setting values:

- REMx absolute setpoint adjuster; see chapter 6.4
- REL relative setpoint adjuster; see chapter 6.5
- FRST frost; see chapter 9

6.2.6 Connection diagrams (examples)

Connection diagram for LG-Ni 1000 sensor

You can connect a passive LG-Ni 1000 temperature sensor to the input. It must be connected according to the following diagram:

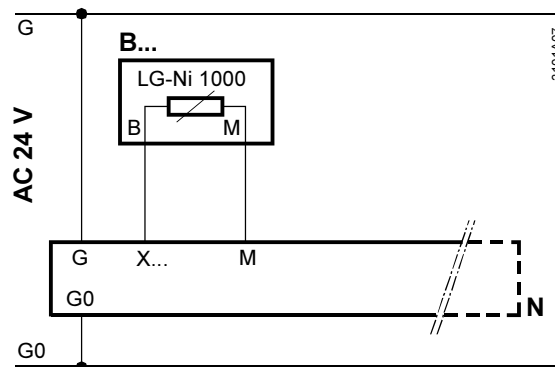

Average measurement with 4 x LG-Ni 1000

It is also possible to take an average temperature measurement with 4 passive sensors. The sensors must be connected according to the following diagram:

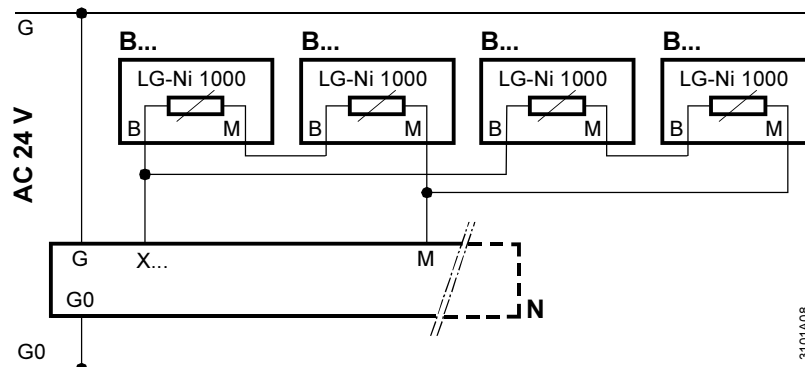

Connection diagram for 2x LG-Ni 1000 sensors

Two passive LG-Ni 1000 temperatures sensor can be connected at the input. The control process uses them to calculate the average temperature. The sensors must be connected according to the following diagram:

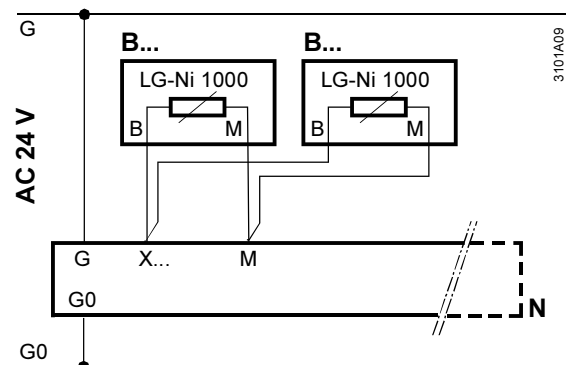

Connection diagram for T1

A passive T1 temperature sensor can be connected at the input. The sensor must be connected according to the following diagram:

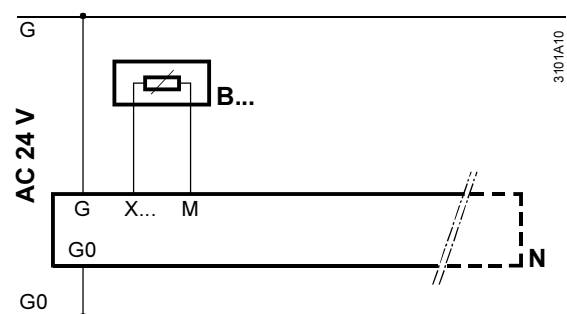

Connection diagram for DC 0...10 V

An active sensor can be connected at the input. The sensor must be connected according to the following diagram:

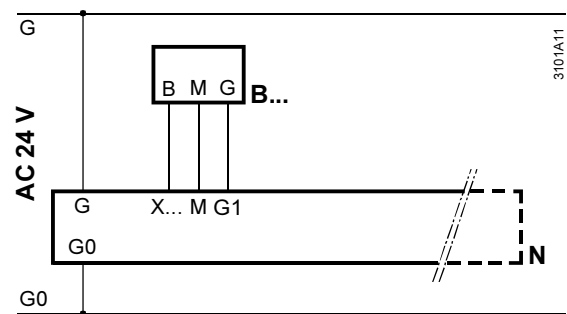

Connection diagram for 0...1000 Ω

A passive setpoint adjuster (e.g. BSG21.1 or QAA25) can be connected at the input. The setpoint adjuster must be connected according to the following diagram:

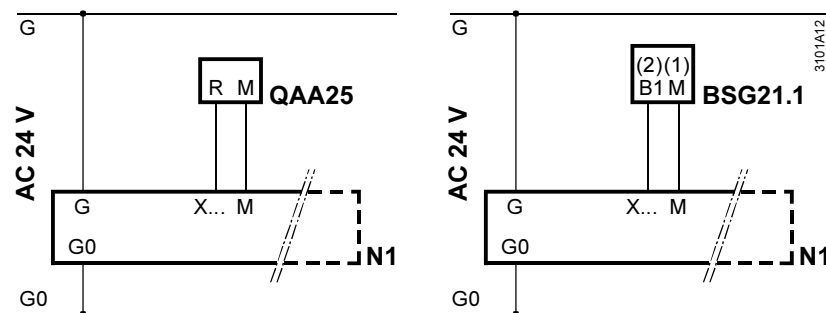

6.2.7 Error handling

Sensor signal monitoring

The controller monitors the active and passive signals as follows:

- When you leave the commissioning menu, the universal controller checks which sensors are connected to it.
 - If one of the sensors that is connected at that time is later missing, a sensor alarm is generated, and the affected sensor is presented on the display as "Xx ----".
 - If the cable is short-circuited (passive sensors only), a sensor alarm is also generated, and the affected sensor is presented on the display as "Xx ooo".
- If a sensor is used for the main controlled variable and an error occurs later on during operation, the controller stops the plant, i.e. it sets the outputs to OFF or 0%.

Caution changing identifiers!

If you change an input identifier after the configuration of the other blocks is completed, the controller may deactivate some functions of the other blocks, because they might otherwise have to operate with units that are invalid for the respective function block.

6.2.8 Settings

Configuration

Path: ... > **COMMIS** > **CONF** > **X1...X5**

<i>Display</i>	<i>Name</i>	<i>Range / remark</i>
LABEL	Input identifier	Assignment of ROOM, OUTS, TEMP, %, 0.0, 0000
SIGNALY	Measured value signal output	Passive temperature sensor output as active signal

Setting values

Path: ... > **PARA** > **X1...X5**

<i>Display</i>	<i>Name</i>	<i>Range</i>	<i>Factory setting</i>
TYPE	Identification	NI, 2XNI, T1, PT, 0-10	NI
MIN VAL	Value low	-50...+9999 (analog signals only)	0
MAX VAL	Value high	-50...+9999 (analog signals only)	100
CORR	Correction	-3.0...+3.0 (°C only)	0 K

Display values

Path: **CHK**

<i>Display</i>	<i>Name</i>	<i>Remarks</i>
X1	X1	Indication of present measured value at terminal X1
...
X5	X5	Indication of present measured value at terminal X5

Wiring test

Path: ... > **COMMIS** > **TEST**

<i>Display</i>	<i>Name</i>	<i>Positions</i>
X1	X1	Indication of present measured value at terminal X1, not adjustable
...
X5	X5	Indication of present measured value at terminal X5, not adjustable

Alarms

<i>Display.</i>	<i>Name</i>	<i>Effect</i>
Xx --- / ooo	Sensor fault Xx...	Non-urgent alarm; plant not stopped. However, if the sensor is used for the main control variable: plant stopped

6.3 Digital inputs (D1, D2, X1...X5)

Purpose and types

Signals for open-loop control functions (e.g. mode selector switch) can be connected to the digital inputs. There are two types of digital input:

- Permanently assigned digital inputs D1 and D2
- Universal inputs X1...X5, activated as digital inputs X1...X5

Normal position

The normal position of each digital input is pre-definable.

The following positions can be chosen: open / closed

Connection diagram

Only voltage-free contacts can be connected to the digital inputs.

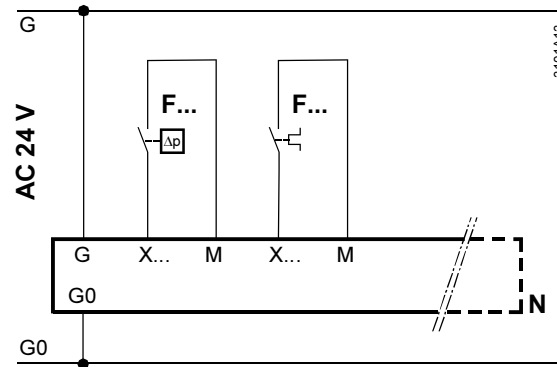

Error handling

The digital signals cannot be monitored. If an important protection function, such as a frost protection unit, is connected to one of these inputs, we recommend that you configure the wiring in such a way that a frost alarm is also generated if there is no signal (cable failure). Setting for normal position: closed.

6.3.1 Settings

Configuration

Path: ... > **COMMIS** > **CONF** > **X1...X5**

Display	Name	Range / remark
LABEL	Input identifier	Assignment of DIG

Setting values

Path: ... > **PARA** > **D1**
 ... > **PARA** > **D2**
 ... > **PARA** > **X1**
 ... > **PARA** > **X5**

Display	Name	Range	Factory setting
NORMPOS	Normal position	OPEN, CLSD	OPEN

Display values

Path: **CHK**

Display	Name	Remarks
D1	D1	Indication of present digital signal at terminal D1
D2	D2	Indication of present digital signal at terminal D2

Wiring test

Path: ... > **COMMIS** > **TEST**

<i>Display</i>	<i>Name</i>	<i>Positions</i>
D1	D1	Indication of present digital signal at terminal D1, not adjustable
D2	D2	Indication of present digital signal at terminal D2, not adjustable

Note

Universal digital inputs X1...X5 are presented as shown in chapter 6.2.8.

6.4 Absolute remote setpoint (REM)

6.4.1 Basic type and suitable setpoint adjusters

Basic type

You can configure an absolute setpoint adjuster both for basic type A and for basic type U.

It acts on the "comfort" and "economy" setpoints.

Suitable setpoint adjusters

Suitable setpoint adjusters are the QAA25 room operation unit (5...35 °C) as well as the BSG21.1 (0...1000 Ω) or BSG61 (DC 0...10 V) devices.

6.4.2 Activating the function

Specify identifier and controller

You can activate the function by setting the identifier of an input as a remote setpoint (REMX).

At the same time you must specify the controller (1...2) that the remote setpoint should act on.

6.4.3 Type and measuring range

Active or passive?

You can choose whether the remote setpoint is an active signal (DC 0...10 V) or a passive signal (0...1000 Ω).

Additionally, you can set the input signal's range:

- MIN VAL value low: lowest measured value at DC 0 V or 0 Ω
- MAX VAL value high: highest measured value at DC 10 V or 1000 Ω

6.4.4 Setpoints for basic type A

Setpoints for "comfort"

You always have to define the comfort setpoints.

The remote setpoint always acts on the "heating" setpoint; the dead zone between Seq1+2 and Seq4+5 remains the same as the dead zone for the permanently preset setpoints.

- Therefore, the present "heating" comfort setpoint:
= remote setpoint
- Therefore, the present "cooling" comfort setpoint:
= remote setpoint + ("cooling" comfort setpoint – "heating" comfort setpoint)

Setpoints for "economy"

The economy setpoints are compensated in the same way.

6.4.5 Setpoints for basic type U

Setpoints for "comfort"

The comfort setpoints always have to be entered.

The remote setpoint always acts on the lower comfort setpoint (SET MIN); the dead zone X_{dz} between Seq1+2 and Seq4+5 remains the same as the dead zone X_{dz} for the permanently preset setpoints.

- Therefore, the present lower comfort setpoint (SET MIN):
= remote setpoint (REMx)
- Therefore, the present higher comfort setpoint (SET MAX):
= remote setpoint (REMx) + (higher comfort setpoint – lower comfort setpoint)

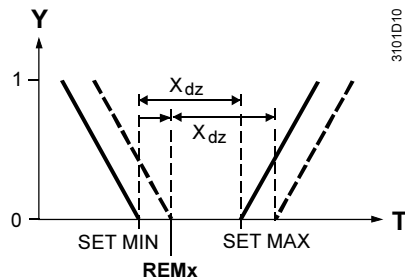

Setpoints for "economy"

The economy setpoints are compensated in the same way.

6.4.6 Error handling

Connection errors

When you leave the commissioning menu, the universal controller checks whether the setpoint adjuster is connected to it.

- If the setpoint adjuster is connected at that time but is later missing during operation, or if there is a short circuit in the cable, the controller generates a sensor alarm and presents it on the display:
 - "Xx ---" => setpoint adjuster missing
 - "Xx ooo" => short circuit
- If there is no signal from the setpoint adjuster at the time, the controller uses the setpoints that are set internally.

Configuration errors

If more than one input has been activated as the remote setpoint adjuster for the same controller, the controller only accepts the first input.

Note

Remote setpoint adjusters BSG21.2, BSG21.3, BSG21.4, QAA26 are not supported.

6.4.7 Settings

Configuration

Path: ... > **COMMIS** > **CONF** > **X1...X5**

Display	Name	Range / remark
LABEL	Input identifier	REMx

Setting values

Path: ... > **PARA** > **X1...X5**

Display	Name	Range	Factory setting
TYPE	Type	0-10, OHM	OHM
MIN VAL	Value low	-50...+9999	0
MAX VAL	Value high	-50...+9999	50

Display values

Path: **CHK**

Display	Name	Remarks
Xx	Xx	Indication of present remote setpoint adjuster value at terminal Xx

Wiring test

Path: ... > **COMMIS > TEST**

Display	Name	Positions
Xx	Xx	Indication of present remote setpoint adjuster value at terminal Xx, not adjustable

Alarms

Display	Name	Effect
Xx --- / 000	Sensor error X...	Non-urgent alarm; plant not stopped.

6.5 Relative remote setpoint (REL)

6.5.1 Basic type and suitable setpoint adjusters

Basic type

You can only configure a relative setpoint adjuster for basic type A. It acts on the "comfort" and "economy" room temperature setpoints.

Suitable setpoint adjusters

Suitable setpoint adjusters are the QAA27 room operation unit (-3...+3 K) or BSG21.5.

6.5.2 Activating the function

Specify identifier (REL)

You can activate the function by setting the identifier of an input as "rem setp adjuster relative (REMx).

You can only activate the relative remote setpoint adjuster for basic type A room temperature controls.

6.5.3 Measuring range

1000...1175 Ω

The setpoint adjuster's range must be 1000...1175 Ω = -3...+3 K.

6.5.4 Setpoints

Setpoints for "comfort"

The relative remote setpoint adjuster acts on the lower comfort setpoint (SET MIN) and the higher comfort setpoint (SET MAX). Therefore, the dead zone X_{dz} between Seq1+2 and Seq4+5 remains the same as the dead zone X_{dz} for the permanently preset setpoints.

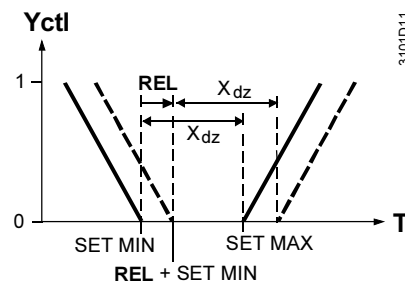

Setpoints for "economy"

The economy setpoints are compensated in the same way.

6.5.5 Error handling

Connection errors

When you leave the commissioning menu, the universal controller checks whether the setpoint adjuster is connected to it.

- If the setpoint adjuster is connected at that time but is later missing during operation, or if there is a short circuit in the cable, the controller generates a sensor alarm and presents it on the display:
 - "Xx ---" => setpoint adjuster missing
 - "Xx ooo" => short circuit
- If there is no signal from the setpoint adjuster at the time, the controller operates without the relative setpoint compensation.

Configuration errors

If you have activated more than one input as the relative remote setpoint adjuster, the controller only accepts the first input.

6.5.6 Settings

Configuration

Path: ... > **COMMIS** > **CONF** > **X1...X5**

<i>Display</i>	<i>Name</i>	<i>Range / remark</i>
LABEL	Input identifier	REL

Display values

Path: **CHK**

<i>Display</i>	<i>Name</i>	<i>Remarks</i>
Xx	Xx	Indication of present relative remote setpoint adjuster value at terminal Xx

Wiring test

Path: ... > **COMMIS** > **TEST**

<i>Display</i>	<i>Name</i>	<i>Positions</i>
Xx	Xx	Indication of present relative remote setpoint adjuster value at terminal Xx, not adjustable

Alarms

<i>Display</i>	<i>Name</i>	<i>Effect</i>
Xx --- / ooo	Sensor error X...	Non-urgent alarm; plant not stopped.

6.6 Outside temperature (OUTS)

6.6.1 Activation and functionality

Activating the function

You can activate the function by setting the identifier **OUTS** (outside temperature) at the respective input.

OUTS (outside temperature) is a special identifier, because it creates a large number of internal connections.

Additional functionality

The other properties, such as measuring range, error handling, etc. are described in chapter 6.2 "Analog inputs".

6.6.2 Settings

Configuration

Path: ... > **COMMIS** > **CONF** > **X1...X5**

<i>Display</i>	<i>Name</i>	<i>Range / remark</i>
LABEL	Input identifier	OUTS

Setting values

Path: ... > **PARA** > **X1**

Path: ... > **PARA** > **X5**

<i>Display</i>	<i>Name</i>	<i>Range</i>	<i>Factory setting</i>
TYPE	Type	NI, 2XNI, T1, PT, 0-10	NI
MIN VAL	Value low	-50...+9999	0
MAX VAL	Value high	-50...+9999	100
CORR	Correction	-3.0...+3.0	0 K

Display values

Path: **CHK**

<i>Display</i>	<i>Name</i>	<i>Remarks</i>
OUTS	Outside temperature	

Wiring test

Path: ... > **COMMIS** > **TEST**

<i>Display</i>	<i>Name</i>	<i>Positions</i>
OUTS	Outside temperature	Indication of the outside temperature (at terminal Xx and as special OUTS point), not adjustable

Alarms

<i>Display</i>	<i>Name</i>	<i>Effect</i>
Xx --- / 000	Sensor error X...	Non-urgent alarm; plant not stopped.

6.7 Room temperature (ROOM)

6.7.1 Activation and functionality

Activating the function

You can activate the function by setting the identifier **ROOM** (room temperature) at the respective input.

ROOM (room temperature) is a special identifier, because it creates a large number of internal connections.

Additional functionality

The other properties, such as measuring range, error handling, etc. are described in chapter 6.2 "Analog inputs".

6.7.2 Settings

Configuration

Path: ... > **COMMIS** > **CONF** > **X1**
... > **COMMIS** > **CONF** > **X5**

<i>Display</i>	<i>Name</i>	<i>Range / remark</i>
LABEL	Input identifier	ROOM

Setting values

Path: ... > **PARA** > **X1...X5**

<i>Display</i>	<i>Name</i>	<i>Range</i>	<i>Factory setting</i>
TYPE	Type	NI, 2XNI, T1, PT, 0-10	NI
MIN VAL	Value low	-50...+9999	0
MAX VAL	Value high	-50...+9999	100
CORR	Correction	-3.0...+3.0	0 K

Display values

Path: **CHK**

<i>Display</i>	<i>Name</i>	<i>Remarks</i>
ROOM	Room temperature	

Wiring test

Path: ... > **COMMIS** > **TEST**

<i>Display</i>	<i>Name</i>	<i>Positions</i>
ROOM	Room temperature	Indication of the room temperature (at terminal Xx and as ROOM display value), not adjustable

Alarms

<i>Display</i>	<i>Name</i>	<i>Effect</i>
Xx --- / 000	Sensor error X...	Non-urgent alarm; plant not stopped.

7 Aggregates

7.1 Pump (PUMP x)

7.1.1 Purpose and activation

Purpose of PUMP x

The PUMP x (pump control) function block controls load-dependent pumps.

Quantity

Depending on device type, the following number of pump controls (PUMP x) are available:

<i>Device type</i>	<i>Number of PUMP x</i>
RLU210	None
RLU222	Max. 2
RLU232	Max. 2
RLU236	Max. 3

Activation

In order to activate the pump control (PUMP x) you must assign a switch output (Qx).

7.1.2 Switching ON/OFF

Not possible via mode

Pumps cannot be switched on and off via the operating mode ("comfort", "economy").

Load-dependent by the sequence controller

The sequence controller can switch the pump on according to load. Up to 2 connections can be wired from the sequence controllers, in which case maximum selection applies.

You can define the switch-on and switch-off points via the "ON-Y" and "OFF-Y" settings. In normal use, we recommend switching the pump on at 5 % load, and switching it off again at 0 % load.

Switch-on according to outside temperature

In order to prevent freezing of water pipes, pumps can be operated permanently at low outside temperatures.

In order to be able to activate this function, an outside temperature signal must be available; see chapter 6.6, Outside temperature (OUTS). You can deactivate this function by setting the "ON-OUTS" limit value to $-50\text{ }^{\circ}\text{C}$.

The controller switches the circulation pump on if the outside temperature falls below the set limit value. It switches the pump off again when the temperature has risen by 2 K above the limit value.

Switch-off delay

You can define a switch-off delay "DLY OFF" for the pumps. The switch-off delay always acts on the switch-off command for:

- Pumps that are switched on according to load via the sequence
- Switch-on according to outside temperature

The switch-off delay does not act on the following switch-off commands:

- Plant stop due to alarm (frost [cooling sequence], main controlled variable not available)
- Wiring test

7.1.3 Error handling

Errors in operation

If the outside temperature signal is not available, and the value for "switch-on according to outside temperature" is not set to -50 °C , the pump remains permanently on.

Note

You cannot assign more than 2 sequences.

7.1.4 Function check / wiring test

Switch ON/OFF

During the wiring test, the pumps can be directly switched on and off via the control switch.

Switch positions

The switch has the following positions:

- Off
- On

7.1.5 Priorities

Four priorities for pump operation

The following priorities apply to pump operations:

- 1 ON / OFF during the wiring test
- 2 ON due to frost protection control (pump on heat sequence)
- 3 ON due to "switch-on according to outside temperature"
- 4 ON according to demand (see sequence controller; chapter 8.8.6 Pump Outputs)

7.1.6 Settings

Configuration

Path: ... > **COMMIS** > **CONF** > **PUMP 1**
... > **COMMIS** > **CONF** > **PUMP 2**
... > **COMMIS** > **CONF** > **PUMP 3**

<i>Display</i>	<i>Name</i>	<i>Range / remark</i>
PUMP x	Output	Output of Pump x (1,2,3) to a relay; adjustable values: ---, Q1, Q2, ... (free outputs only)

Setting values

Path: ... > **PARA** > **PUMP 1**
... > **PARA** > **PUMP 2**
... > **PARA** > **PUMP 3**

<i>Display</i>	<i>Name</i>	<i>Range</i>	<i>Factory setting</i>
ON-Y	Load-dependent ON	0...100 %	5 %
OFF-Y	Load-dependent OFF	0...100 %	0 %
ON-OUTS	Outside temp-dependent ON	$-50\dots+150\text{ °C}$	-50 °C
DLY OFF	Switch-off delay	00.00...60.00 m.s	00.00

Display values

Path: **CHK**

<i>Display</i>	<i>Name</i>	<i>Remarks</i>
PUMP 1	Pump 1	Indication of present state: OFF, ON
PUMP 2	Pump 2	Indication of present state: OFF, ON
PUMP 3	Pump 3	Indication of present state: OFF, ON

Wiring test

Path: ... > **COMMIS** > **TEST**

Display	Name	Positions
PUMP 1	Pump 1	OFF, ON
PUMP 2	Pump 2	OFF, ON
PUMP 3	Pump 3	OFF, ON

7.1.7 Application examples

Frost protection pump

Pump used as a frost protection pump on an air heater:

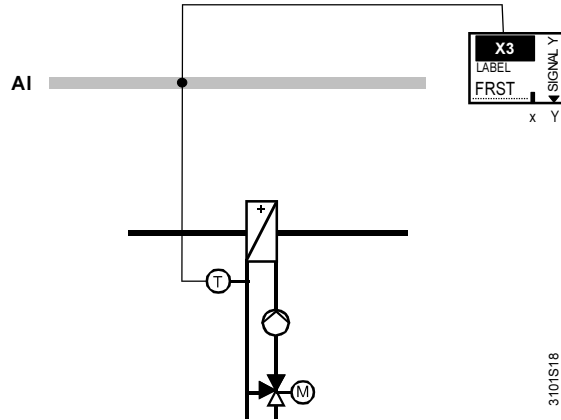

Load-dependent recooling pump

Pump used as a load-dependent recooling pump on a stepped refrigeration machine:

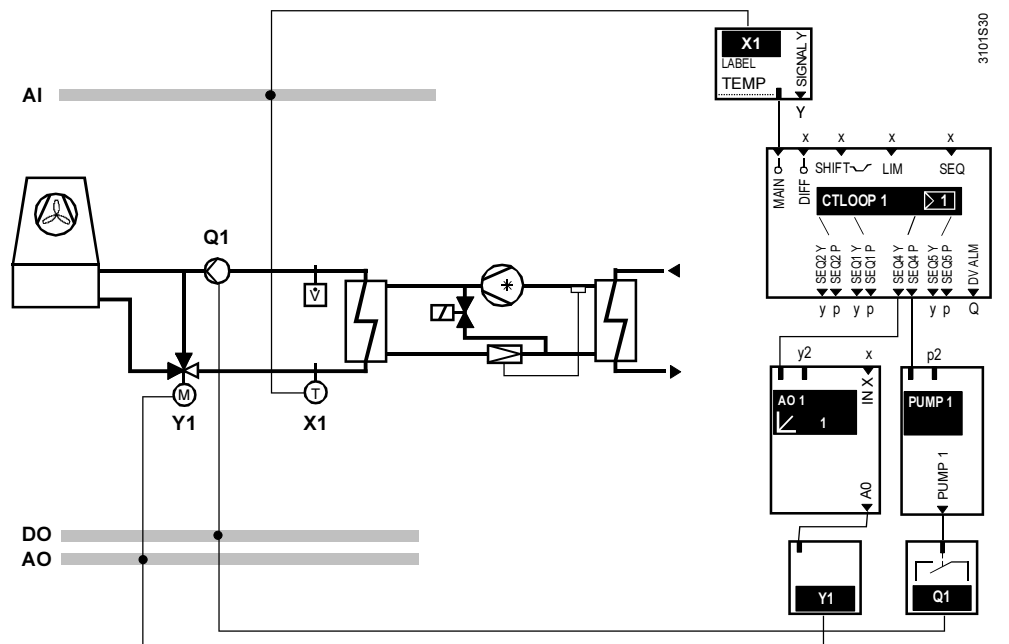

7.2 Modulating output (AO x)

7.2.1 Purpose and activation

Purpose of AO x

The AO x (modulating output) function block generates a modulating DC 0...10 V output signal for a modulating actuator with a corresponding input.

Activation

In order to activate the AO x function block, you must assign an output (Y x) to it.

7.2.2 Functions

External signal (IN X)

You can connect the load signal for the modulating output from the sequence controller to the modulating output.

Additionally, it is also possible to use an analog input (IN X) as the load signal. If one or more (maximum 2) internal load signals and the external load signal are connected at the same time, the controller uses maximum selection.

For example, this provides for combination of the air cooler signal from an external dehumidification controller with that from a temperature controller.

Note

The controller only includes the external signal if it is in the "comfort" or "economy" mode.

Output inversion (INVERS)

You can invert any output. Meanings:

INVERS = NO: 0...100 % load = 0...100 % output

INVERS = YES: 0...100 % load = 100...0 % output

If the controller has an analog output and is switched off during operation (input D1 = protection mode), the output signal behaves like this:

INVERS = NO: 0 % output

INVERS = YES: 100 % output

Limits

(MIN POS, MAX POS)

You can impose upper and lower limits on the modulating output.

In that case, 0...100 % output means "positioning signal min (MIN POS)...positioning signal max (MAX POS)" as shown below:

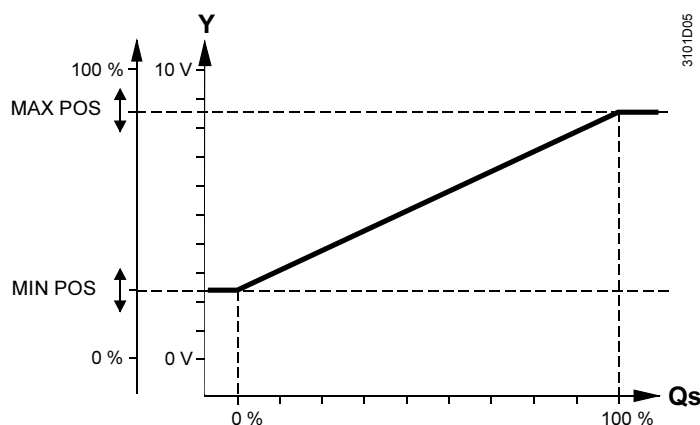

Qs = load demand from the sequence controller

Application example

You can use this feature to parameterize the output for a solenoid valve with a DC 5...7.5 V input signal, for example.

7.2.3 Error handling

Signal interpretation

The controller interprets external signals at IN X with input values below 0 V as 0 %, and signals with values over 10 V as 100 %. It performs linear interpolation on all values in between.

Important: Pay attention to hardware limitations!

Note

You cannot assign more than 2 sequences.

7.2.4 Wiring test (TEST)

Switch ON/OFF

During the wiring test, the modulating output can be directly commanded via the control switch.

Switch positions

The switch has the following positions:

- ---
- 0...100 % load

Note

Settings such as INVERS, MIN POS and MAX POS are also effective during the wiring test.

7.2.5 Settings

Configuration

Path: ... > **COMMIS** > **CONF** > **AO 1**
 ... > **COMMIS** > **CONF** > **AO 2**
 ... > **COMMIS** > **CONF** > **AO 3**

Display	Name	Range / remark
AO x	Modulating output	Activates the modulating output; adjustable values: ---, Y1, Y2, Y3
IN X	Preselection external	Adjustable values: ---, X1, X2, ... (inputs with identifier % only)

Setting values

Path: ... > **PARA** > **AO 1**
 ... > **PARA** > **AO 2**
 ... > **PARA** > **AO 3**

Display	Name	Range	Factory setting
MIN POS	Positioning signal min	0...100 %	0 %
MAX POS	Positioning signal max	0...100 %	100 %
INVERS	Inversion	NO, YES	NO

Display values

Path: **CHK**

Display	Name	Remarks
AO 1	Modulating output 1	0...100 %
AO 2	Modulating output 2	0...100 %
AO 3	Modulating output 3	0...100 %

Wiring test

Path: ... > **COMMIS** > **TEST**

Display	Name	Positions
AO 1	Modulating output 1	---, 0...100 %
AO 2	Modulating output 2	---, 0...100 %
AO 3	Modulating output 3	---, 0...100 %

7.3 Heat recovery equipment/mixed air damper (HREC)

7.3.1 Purpose and activation

Purpose of HREC

The HREC function block controls a heat recovery unit or a mixing damper with a DC 0...10 V signal.

Activation

In order to activate the HREC function block, you must assign an output (Y x) to it.

Notes

If you use the HREC function block to control a mixing damper, ensure that the "TYPE" is set to "DMP". This refers to the control of the outdoor air damper.

7.3.2 External preselection (IN X)

Maximum selection in case of multiple load signals

You can connect the load signal for the heat recovery unit from the sequence controller to the heat recovery unit.

Additionally, it is also possible to use an analog input (IN X) as the load signal.

If one or more (maximum 2) internal load signals and an external load signal are connected at the same time, the controller uses maximum selection. This provides for combination of an external load signal from another RLU2.. universal controller with the internal maximum economy changeover (MECH), for example.

Note

The controller only includes the external signal if it is in the "comfort" or "economy" mode.

7.3.3 Heat recovery unit switchover (TYPE)

Output inversion

In order to produce the switchover between heat recovery unit (wheel, glycol) and mixing damper, you can invert the output signal using TYPE.

Settings

You have to make the following settings in normal operation to achieve the customary control response:

- Energy recovery unit _ TYPE = ERC 0...100 % load = 0...100 % output
- Mixing damper _/ TYPE = DMP 0...100 % load = 100...0 % output

Output signal behavior

If the controller has a heat recovery unit / mixing damper output and is switched off during operation (input D1 = protection mode ), the output signal behaves like this:

- TYPE = ERC: 0 % (i.e. DC 0 V)
- TYPE = DMP: 0 % (i.e. DC 0 V)

7.3.4 Limits (MIN POS, MAX POS)

Diagram

You can impose upper and lower limits on the modulating output.
In that case, a 0... 100 % output signal means "positioning signal min (MIN POS)...positioning signal max (MAX POS)":

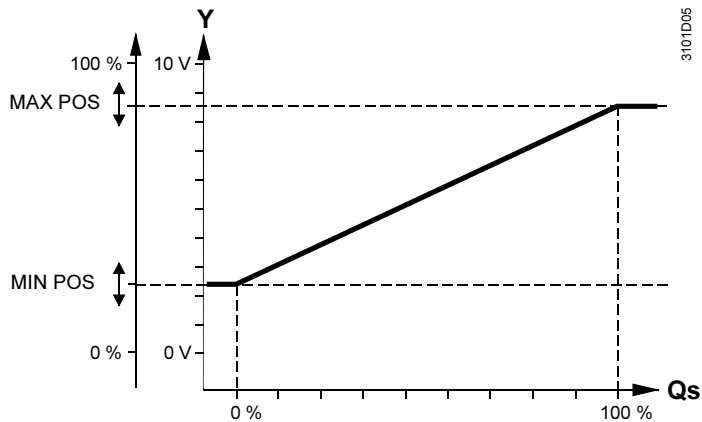

Q_s = load demand from the sequence controller

Application example

You can implement a minimum damper position using positioning signal min (MIN POS).

Note

The controller does not include MIN POS and MAX POS in protective mode.

7.3.5 Maximum economy changeover (MECH)

Purpose

The purpose of this function is to optimize the control of the heat recovery in air-conditioning systems with regard to operating costs. It compares the available energy in the outdoor air and exhaust air, and switches the inversion accordingly.

Activation

In order to activate the maximum economy changeover (MECH) function, assign the corresponding inputs during configuration:

- MECH 1 (MECH input 1)
- MECH 2 (MECH input 2)

Three changeover possibilities

The following three changeover possibilities are available:

- Changeover via an external digital signal
- Changeover at an adjustable value
- Changeover at an adjustable difference between two measured values

Special application examples:

- Changeover via external digital signal with damper as first cooling sequence
- Changeover at adjustable difference with damper as first cooling sequence

The three possibilities and the two special application possibilities are explained on the following pages.

Maximum economy changeover (MECH), continued

Possibility 1: Changeover via an external digital signal

In order to achieve this, you must assign a digital input to MECH input 1 (MECH 1).
 The following applies:
 Normal position => no inversion of the HR output (HREC)
 Operating position => inversion of the HR output (HREC)

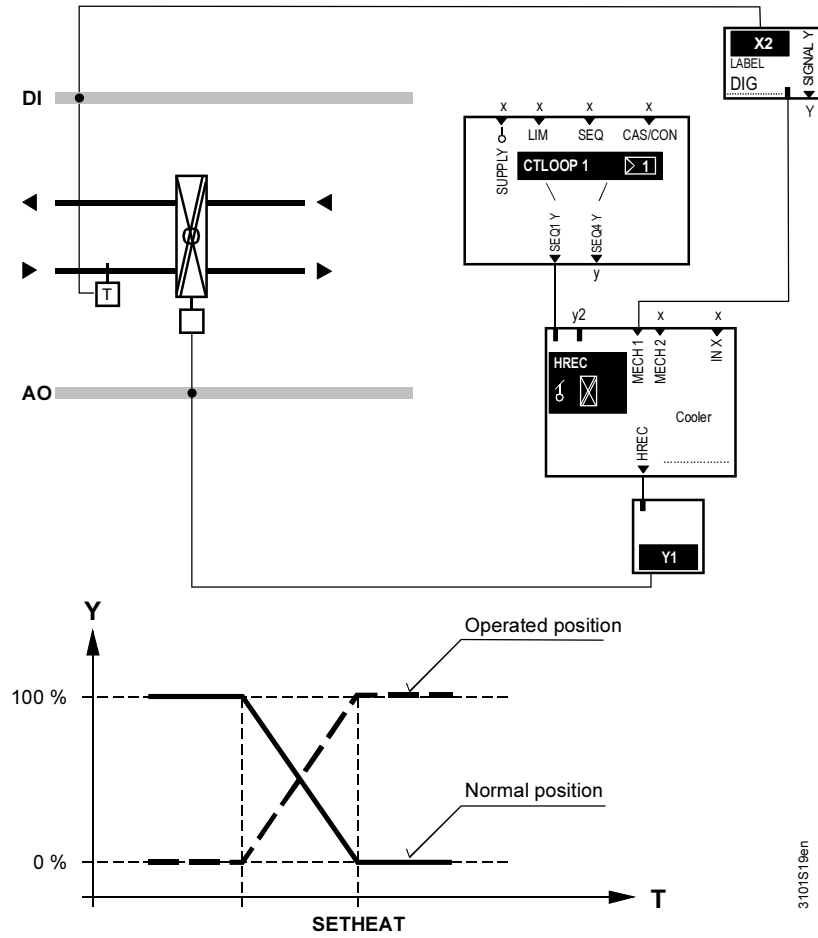

3101S19en

Application example

Changeover via an external control element (digital input).

Maximum economy changeover (MECH), *continued*

Possibility 2: Changeover at an adjustable value

In order to achieve this, you must assign an analog input to MECH input 1 (MECH 1).
Function:
If the set MECH limit value (MECHSET) is exceeded, the heat recovery output (HREC) is inverted.

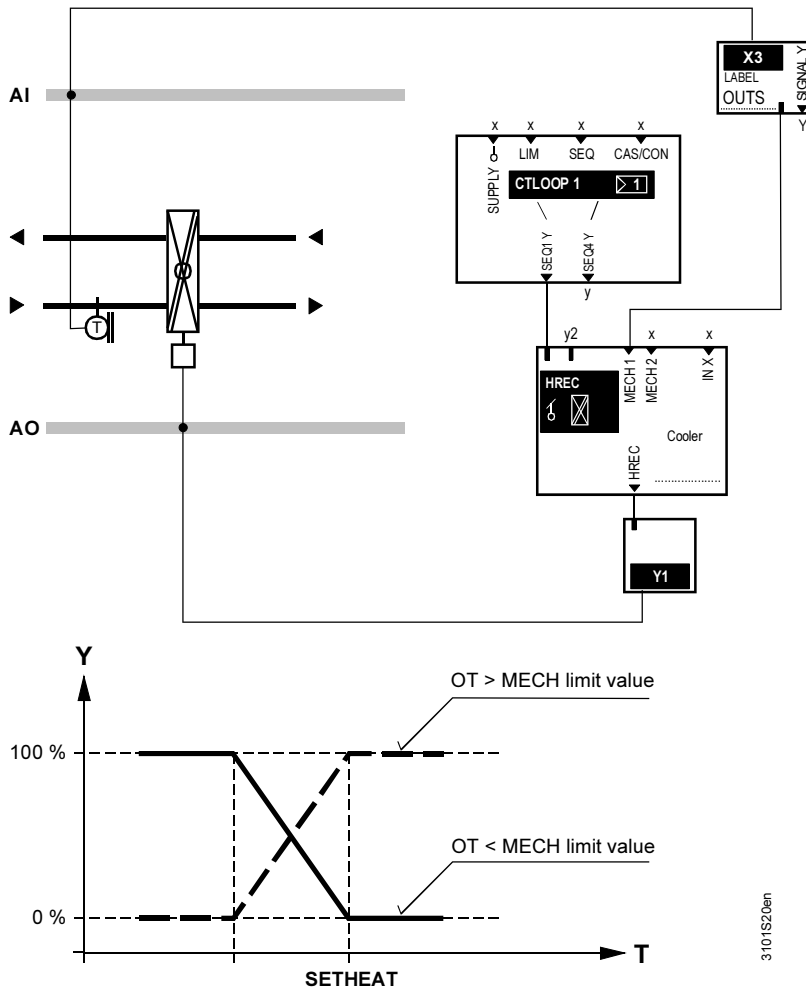

Application examples

Examples of changeover at an adjustable value:

- Changeover at an outside temperature > 25 °C
- Changeover at an outside enthalpy > 30 kJ/kg
- Changeover via an external enthalpy difference calculator at an enthalpy difference ≥ 2 kJ/kg

Maximum economy changeover (MECH), *continued*

Possibility 3: Changeover at an adjustable difference

In order to achieve changeover at an adjustable difference between two measured values, you must assign one analog input each to MECH input 1 (MECH 1) and MECH input 2 (MECH 2).

If the set MECH limit value (MECHSET) is exceeded, the heat recovery output (HREC) is inverted.

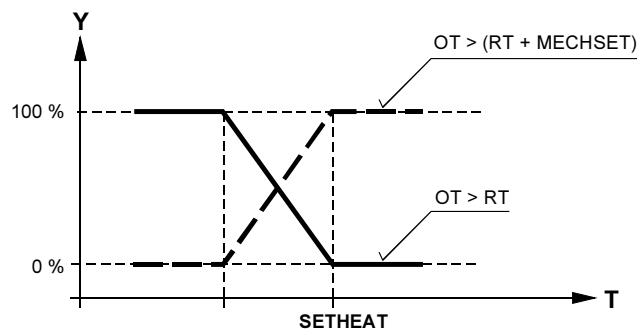
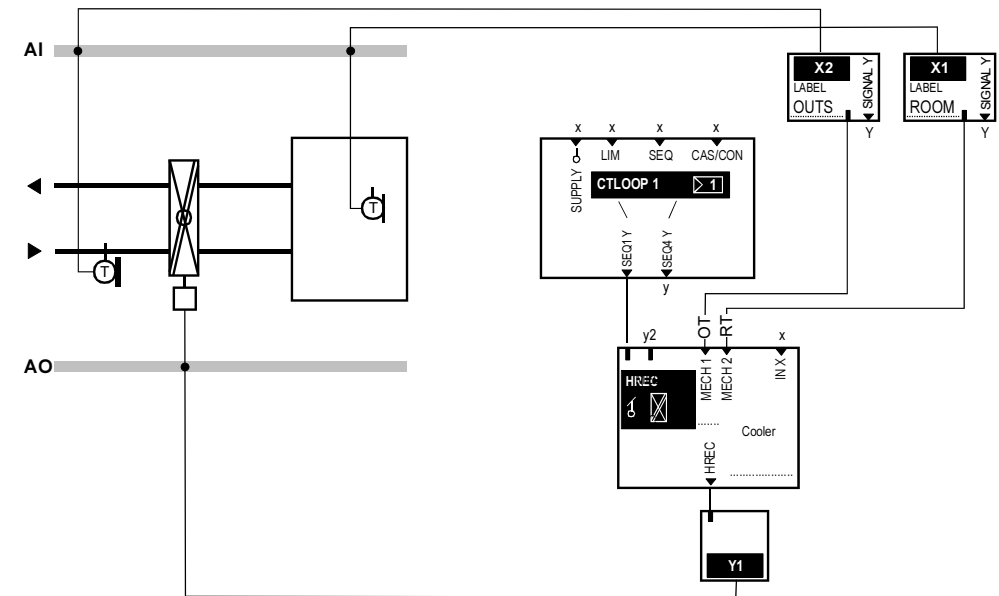

310/IS21en

Application examples

Examples of changeover at an adjustable difference:

- Changeover at a temperature difference of:
outside temperature – room temperature ≥ 3 K
- Changeover at a temperature difference of:
outdoor air temperature – exhaust air temperature ≥ 2 K

Maximum economy changeover (MECH), *continued*

Special application
example 1:
Changeover via external
digital signal with damper
as first cooling sequence

In order to achieve this, you must assign a digital input to MECH input 1 (MECH 1).
The following applies:
Normal position => inversion of mixed air damper output (HREC)
Operating position => no inversion of mixed air damper output (HREC)

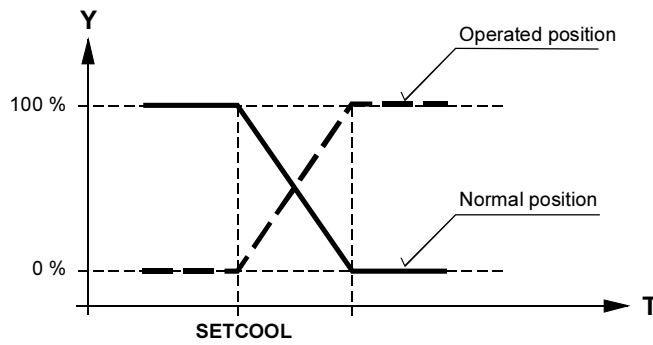
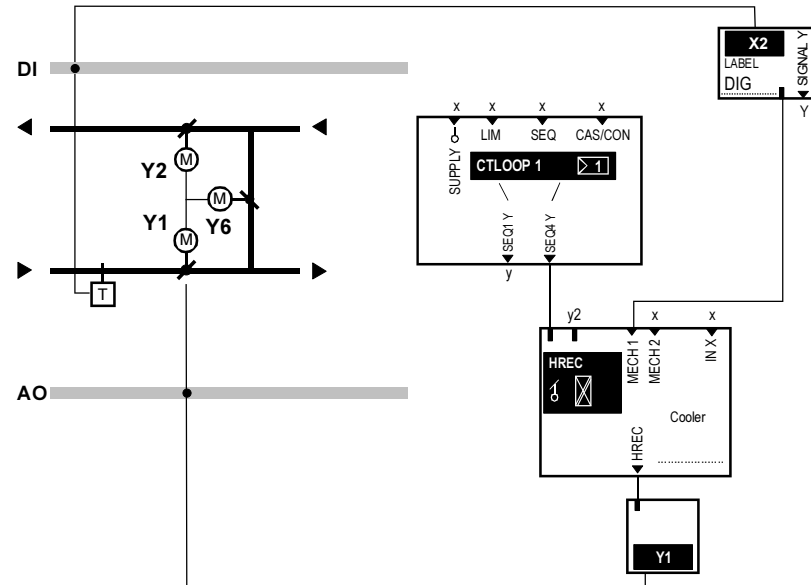

3101S40en

Maximum economy changeover (MECH), *continued*

Special application
example 2:
Changeover at adjustable
difference with damper as
first cooling sequence

In order to achieve changeover at an adjustable difference between two measured values, you must assign one analog input each to MECH input 1 (MECH 1) and MECH input 2 (MECH 2). Assign the room temperature to MECH input 1, and the outside temperature to MECH input 2.
If the set MECH limit value (MECHSET) is exceeded, the damper output (HREC) is inverted.

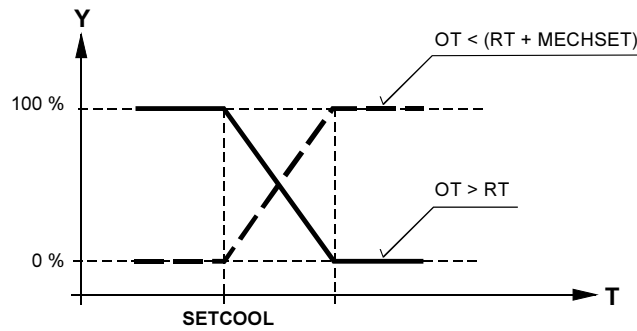
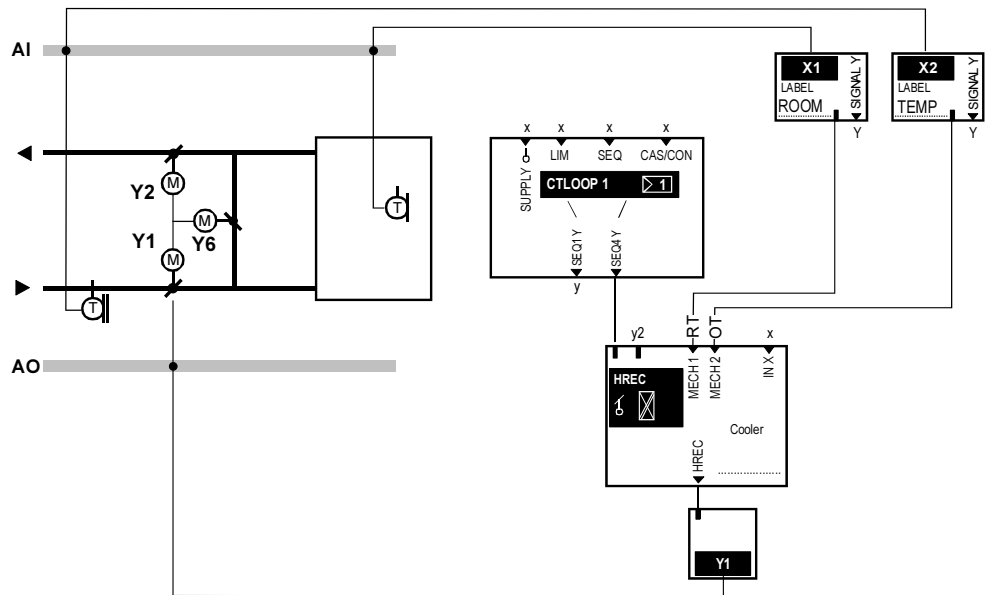

3101S41en

7.3.6 Fixed preselection during cooling operation (COOLER)

Problem

If you are using the air cooler for dehumidification, the temperature control can sometimes demand more heat from the heat recovery unit, which then has to be dissipated again in the air cooler.

Solution

You can avoid this problem by assigning the respective cooling valve to the heat recovery unit via the COOLER setting. If the cooling valve is open, the heat recovery output signal is then set such that the air has as low a temperature as possible after the heat recovery unit.

Example

Dehumidification and heating in a partial air-conditioning system

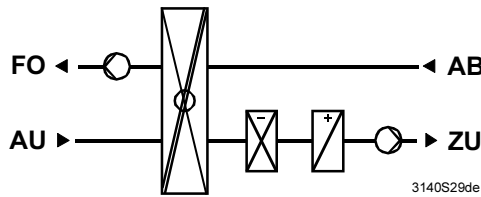

Process without cooling valve setting:

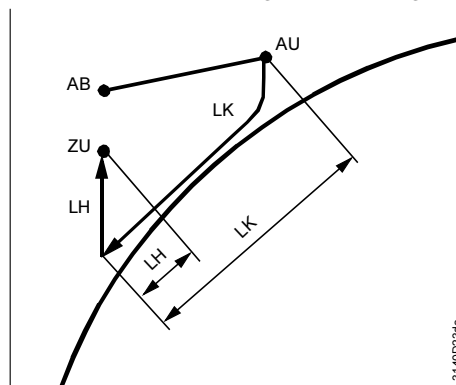

Process with cooling valve setting:

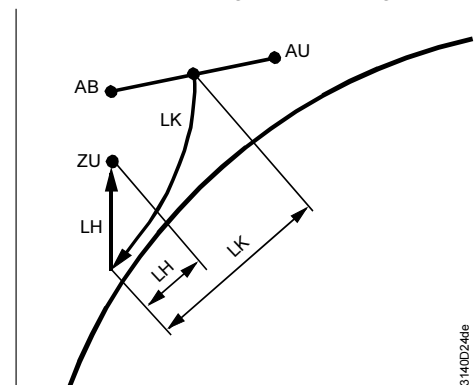

7.3.7 Wiring test (TEST)

Direct control via control switch

During the wiring test, the modulating output can be directly commanded via the control switch. Maximum economy changeover (MECH) is inactive.

The switch has the following positions:

- ---
- 0...100 % load

Note

Settings such as TYPE, MIN POS and MAX POS are also effective during the wiring test.

7.3.8 Error handling

Errors in operation

If the sensors for MECH are not available, the changeover does not occur.

Configuration errors

If the second MECH input does not have the same unit as the first MECH input, only the first input is used for the changeover. If no input or only the second input is configured, the changeover is deactivated.

7.3.9 Settings

Configuration

Path: ... > **COMMIS** > **CONF** > **HREC**

<i>Display</i>	<i>Name</i>	<i>Range / remark</i>
HREC	Mixing damper/HR	Activates heat recovery; adjustable values: ---, Y1, Y2, ...
MECH 1	MECH input 1	Adjustable values: ---, X1, X2, ... (only °C, 0.0, 0000, digital)
MECH 2	MECH input 2	Adjustable values: ---, X1, X2, ... (only °C, 0.0, 0000)
COOLER	Air cooling coil valve	---, AO1, AO2, AO3, STP1, STP2, STP3, SLIN, SBIN, 3P
IN X	Preselection external	Adjustable values: ---, X1, X2, ... (inputs with identifier % only)

Setting values

Path: ... > **PARA** > **HREC**

<i>Display</i>	<i>Name</i>	<i>Range</i>	<i>Factory setting</i>
MIN POS	Positioning signal min	0...100 %	0 %
MAX POS	Positioning signal max	0...100 %	100 %
MECHSET	MECH limit value		3 K, 20 °C
TYPE	Type	ERC, DMP	ERC

Display values

Path: **CHK**

<i>Display</i>	<i>Name</i>	<i>Remarks</i>
HREC	Mixing damper/HR	0...100 %

Wiring test

Path: ... > **COMMIS** > **TEST**

<i>Display</i>	<i>Name</i>	<i>Positions</i>
HREC	Mixing damper/HR	---, 0...00 %

7.4 Variable step switch (STEP Vx)

7.4.1 Purpose and activation

Purpose of STEP Vx

The STEP Vx (variable step switch) function block switches multi-step aggregates. All outputs can be set individually.

Quantity

Depending on device type, the following number of variable step switches are available:

Device type	Number of variable step switches
RLU210	None
RLU222	1 = with a maximum of 2 steps
RLU232	1 = with a maximum of 2 steps
RLU236	1 = with a maximum of 6 steps 1 = with a maximum of 2 steps (6 relays available in total)

Activation

In order to activate the variable step switch, assign a relay Q... to the STEP 1 output.

Note

Additionally, you can also configure the available analog output AO with each step switch. The same settings are possible as with the modulating output, i.e. the AO function block. Therefore, you can also assign an output Y.

7.4.2 Operating principle

Load connection

With variable step switching, you can set the digital outputs individually according to the load.

You can define the digital output's direction of action via the switching point settings. The digital outputs can overlap each other.

Example

The following diagram shows an example of load connection.

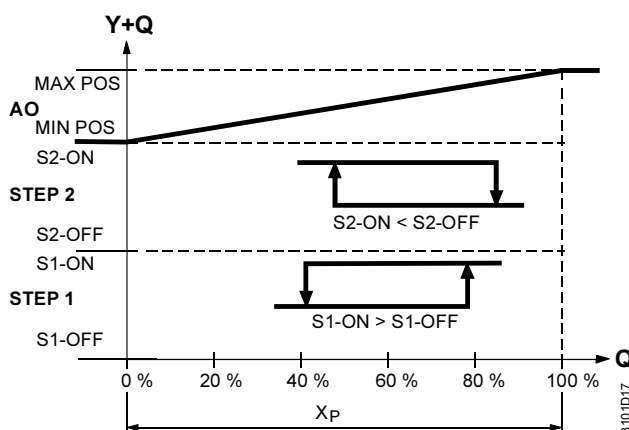

If the step switch is controlled by two internal sequence controllers, the larger signal is effective (maximum selection).

Locking time (OFFTIME)

Additionally, you can enter a common locking time for the digital outputs. This ensures that a step which has just switched off remains off for the set period of time.

No run-on time in the step switch

You cannot enter a run-on time for the step switches, since there are no open-loop control functions in the Synco 200 product range.

Operating principle, *continued*

Note

If the variable step switch is controlling an electric air heater, you must solve the fan run-on using external means.

7.4.3 Preselection external (IN X)

Maximum selection in case of multiple preselections

You can configure an analog input as a preselection for the step switch. The controller performs a maximum selection with the internal signals.

For example, you can use this feature to implement the following function: External control. The RLU236 provides the step switch function only.

Note

The controller only includes the external signal if it is in the "comfort" or "economy" mode.

7.4.4 Output inversion (INVERS)

Definition and behavior

You can invert the analog output. Meanings:

INVERS = NO: 0...100 % load = 0...100 % output

INVERS = YES: 0...100 % load = 100...0 % output

If the controller has a variable step switch and is switched off during operation (input D1 = protection mode), the output signal behaves like this:

INVERS = NO: 0 % output

INVERS = YES: 100 % output

7.4.5 Function check / wiring test

Switch ON/OFF

During the wiring test, the step switch can be controlled directly via the control switch.

Switch positions

The switch has the following positions:

- ---
- 0...100 % load

Note

Settings such as INVERS, MIN POS and MAX POS are also effective during the wiring test.

7.4.6 Priorities

Two priorities

The following two priorities apply to the step switch:

- 1 ON / OFF during the wiring test
- 2 Demand-controlled by the sequence controller (preselection in normal operation) and the IN X external signal (maximum selection)

7.4.7 Settings

Configuration

Path: ... > **COMMIS** > **CONF** > **STEP V1**

... > **COMMIS** > **CONF** > **STEP V2**

<i>Display</i>	<i>Name</i>	<i>Range / remark</i>
STEP 1	Step 1	Activates the step switch, and selects the number of steps; adjustable values: ---, Q1, Q2, ... (free outputs only)
STEP 2	Step 2	---, Q1, Q2, ... (free outputs only)
STEP 3	Step 3	---, Q1, Q2, ... (free outputs only)
STEP 4	Step 4	---, Q1, Q2, ... (free outputs only)
STEP 5	Step 5	---, Q1, Q2, ... (free outputs only)
STEP 6	Step 6	---, Q1, Q2, ... (free outputs only)
AO	Modulating output	---, Y1, Y2, ... (free outputs only)
IN X	Preselection external	---, X1, X2, ... (inputs with identifier % only)

Setting values

Path: ... > **PARA** > **STEP V1**

... > **PARA** > **STEP V2**

<i>Display</i>	<i>Name</i>	<i>Range</i>	<i>Factory setting</i>
S1-ON	[Step 1] ON	0...100 %	17 %
S1-OFF	[Step 1] OFF	0...100 %	0 %
S2-ON	[Step 2] ON	0...100 %	33 %
S2-OFF	[Step 2] OFF	0...100 %	17 %
S3-ON	[Step 3] ON	0...100 %	50 %
S3-OFF	[Step 3] OFF	0...100 %	33 %
S4-ON	[Step 4] ON	0...100 %	67 %
S4-OFF	[Step 4] OFF	0...100 %	50 %
S5-ON	[Step 5] ON	0...100 %	83 %
S5-OFF	[Step 5] OFF	0...100 %	67 %
S6-ON	[Step 6] ON	0...100 %	100 %
S6-OFF	[Step 6] OFF	0...100 %	83 %
OFFTIME	Locking time	00.00...10.00 m.s	00.00 m.s
MIN POS	Positioning signal min	0...100 %	0 %
MAX POS	Positioning signal max	0...100 %	100 %
INVERS	Inversion	NO, YES	NO

Note

STEP V1 has a maximum of 2 steps.

Therefore, the setting values for S3-ON to S6-OFF are not shown.

Display values

Path: **CHK**

<i>Display</i>	<i>Name</i>	<i>Remarks</i>
STEP V1	Variable step switch 1	0...100 %
STEP V2	Variable step switch 2	0...100 %

Wiring test

Path: ... > **COMMIS** > **TEST**

<i>Display</i>	<i>Name</i>	<i>Positions</i>
STEP V1	Variable step switch 1	---, 0...100 %
STEP V2	Variable step switch 2	---, 0...100 %

7.5 Linear step switch (STEPLIN)

7.5.1 Purpose and activation

Purpose of STEPLIN

The STEPLIN (linear step switch) function block switches multi-step aggregates. The load distribution to the outputs is linear.

Quantity

Depending on device type, the following number of linear step switches are available:

Device type	Number of linear step switches
RLU210	None
RLU222	None
RLU232	1 linear step switch with a maximum of: – 2 relay outputs – 1 modulating output
RLU236	1 linear step switch with a maximum of: – 6 relay outputs – 1 modulating output

Activation

In order to activate the linear step switch, assign a relay Q... to the STEP 1 output.

7.5.2 Operating principle

Load connection

The linear step switch connects the relay outputs in equal steps. Load connection takes place according to the following pattern:

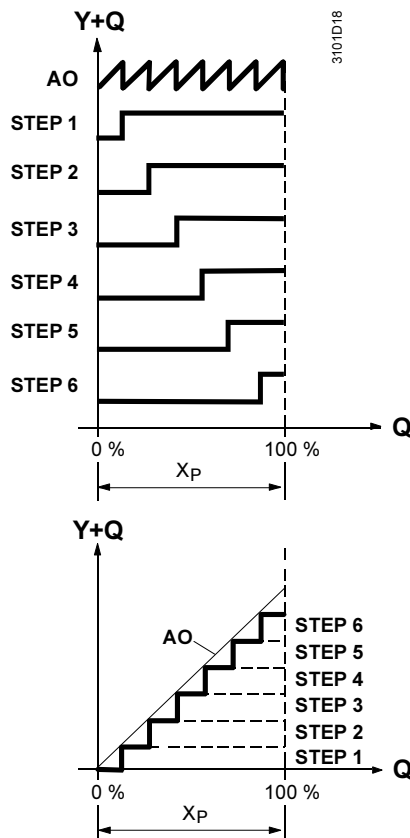

Switching interval

Example with 2 digital outputs:

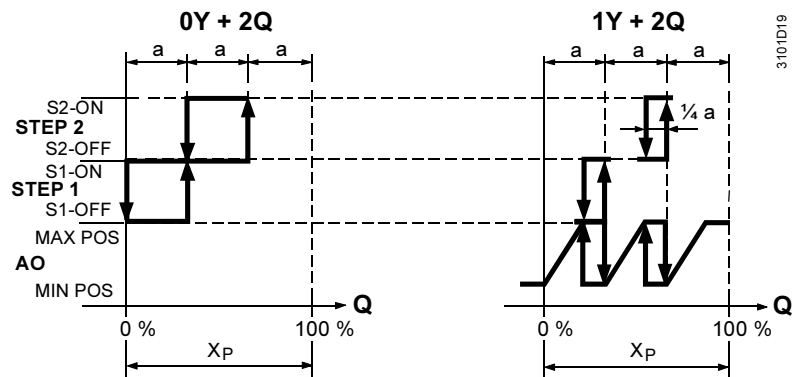

$$\text{Interval } a = \frac{100 \% \text{ load}}{(\text{number of steps} + 1)}$$

Locking time (OFFTIME)

Additionally, you can enter a common locking time for the relay outputs. This ensures that a step that has just switched off remains off for the set period of time.

Startup delay (ON DLY)

In order to prevent excessively quick startup, you can enter a common startup delay time. This delay makes the controller wait for the set time between the steps during startup.

Run priority changeover (PRIO CH)

With the linear step switch, you can set a priority changeover of the outputs.

The priorities change at fixed intervals of roughly one week (always after $7 \times 24 = 168$ hours).

The changeover takes place like this (example with 4 steps):

Week 1:	1, 2, 3, 4
Week 2:	2, 3, 4, 1
Week 3:	3, 4, 1, 2
Week 4:	4, 1, 2, 3
Week 5:	1, 2, 3, 4
etc.	

Notes

The priority changeover is reset in case of a power outage.

7.5.3 External preselection (IN X)

Maximum selection

You can configure an analog input (IN X) as a preselection for the step switch. The controller performs a maximum selection with the internal signals.

Example

For example, you can use this feature to implement the following function:

DX cooling coil control, maximum selection between internal temperature control and dehumidification signal from an external dehumidification controller.

Note

The controller only includes the external signal if it is in the "comfort" or "economy" mode.

7.5.4 Output inversion (INVERS)

Definition and behavior

You can invert the step switch's analog output. Meanings:

INVERS = NO: 0...100 % load = 0...100 % output

INVERS = YES: 0...100 % load = 100...0 % output

The same settings are possible for this analog output as for the modulating output, i.e. the AO function block.

If the controller has a linear step switch and is switched off during operation (input D1 = protection mode), the output signal behaves like this:

INVERS = NO: 0 % output

INVERS = YES: 100 % output

7.5.5 Function check / wiring test

Switch ON/OFF

During the wiring test, the step switch can be controlled directly via the control switch.

Switch positions

The switch has the following positions:

- ---
- 0...100 %

Note

Settings such as INVERS, MIN POS and MAX POS are also effective during the wiring test.

7.5.6 Priorities

The following two priorities apply to the step switch:

- 1 ON / OFF during the wiring test
- 2 Demand-controlled by the sequence controller (preselection in normal operation) and the external preselection (maximum selection)

7.5.7 Settings

Configuration

Path: ... > **COMMIS** > **CONF** > **STEPLIN**

<i>Display</i>	<i>Name</i>	<i>Range / remark</i>
STEP 1	Step 1	Activates the step switch, and selects the number of steps; adjustable values: ---, Q1, Q2, ... (free outputs only)
STEP 2	Step 2	---, Q1, Q2, ... (free outputs only)
STEP 3	Step 3	---, Q1, Q2, ... (free outputs only)
STEP 4	Step 4	---, Q1, Q2, ... (free outputs only)
STEP 5	Step 5	---, Q1, Q2, ... (free outputs only)
STEP 6	Step 66	---, Q1, Q2, ... (free outputs only)
AO	Modulating output	---, N.Y1, N.Y2, ... (free outputs only)
IN X	Preselection external	---, X1, X2, ... (inputs with identifier % only)

Setting valuesPath: ... > **PARA** > **STEPLIN**

<i>Display</i>	<i>Name</i>	<i>Range</i>	<i>Factory setting</i>
ON DLY	Startup delay	00.00...00.10 mm.ss	00.00
PRIO CH	Run priority changeover	NO, YES	NO
OFFTIME	Locking time	00.00...00.10 mm.ss	00.00
MIN POS	Positioning signal min	0...100 %	0 %
MAX POS	Positioning signal max	0...100 %	100 %
INVERS	Inversion	NO, YES	NO

Display valuesPath: **CHK**

<i>Display</i>	<i>Name</i>	<i>Remarks</i>
STEPLIN	Linear step switch	0...100 %

Wiring testPath: ... > **COMMIS** > **TEST**

<i>Display</i>	<i>Name</i>	<i>Positions</i>
STEPLIN	Linear step switch	---, 0...100 %

7.6 Binary step switch (STEPBIN)

7.6.1 Purpose and activation

Purpose of STEPBIN

The STEPBIN (binary step switch) function block switches multi-step aggregates. The aggregates must be sized according to the binary load distribution.

Quantity

Depending on device type, the following number of binary step switches are available:

<i>Device type</i>	<i>Number of binary step switches</i>
RLU210	None
RLU222	None
RLU232	1 binary step switch with a maximum of: – 2 relay outputs(= 3 load steps) – 1 modulating output
RLU236	1 binary step switch with a maximum of: – 4 relay outputs(= 15 load steps) – 1 modulating output

Activation

In order to activate the binary step switch, assign a relay Q... to the STEP 1 output.

7.6.2 Operating principle

Load distribution (demand calculation)

The binary step switch distributes the digital outputs with the number of load steps according to the following table over the total contact rating of the aggregate.

a) If configured **without** the analog output:

<i>Configured outputs</i>	<i>Load distribution</i>				<i>Number of load steps</i>
	<i>Relay 1</i>	<i>Relay 2</i>	<i>Relay 3</i>	<i>Relay 4</i>	
0Y+2Q	Q1 = 1/3	Q2 = 2/3			3
0Y+3Q	Q1 = 1/7	Q2 = 2/7	Q3 = 4/7		7
0Y+4Q	Q1 = 1/15	Q2 = 2/15	Q3 = 4/15	Q4 = 8/15	15

b) If configured **with** an analog output:

<i>Configured outputs</i>	<i>Load distribution</i>					<i>Number of load steps</i>
	<i>Y</i>	<i>Relay 1</i>	<i>Relay 2</i>	<i>Relay 3</i>	<i>Relay 4</i>	
1Y+2Q	Y = 1/4	Q1 = 1/4	Q2 = 2/4			4
1Y+3Q	Y = 1/8	Q1 = 1/8	Q3 = 2/8	Q3 = 4/8		8
1Y+4Q	Y = 1/16	Q1 = 1/16	Q2 = 2/16	Q3 = 4/16	Q4 = 8/16	16

Explanation

0Y = no analog output

1Y = 1 analog output

Load connection

Load connection takes place according to the following pattern:

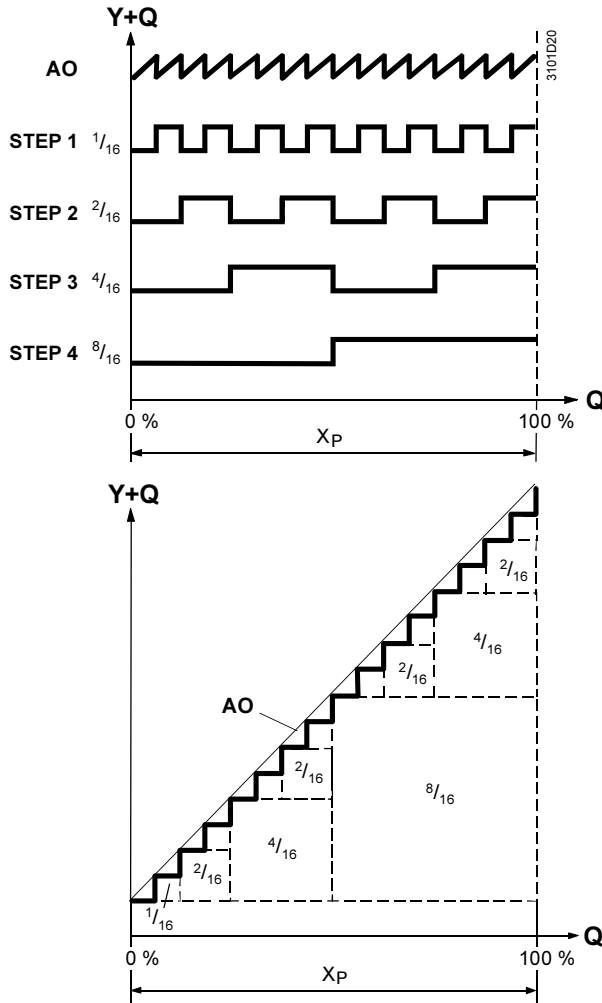

Switching interval

Example with 2 digital outputs:

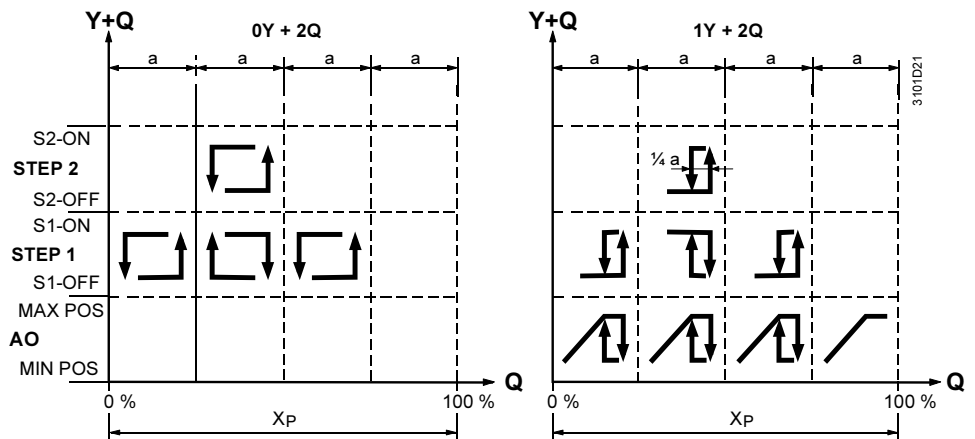

Locking time (OFFTIME)

Additionally, you can enter a common locking time for the relay outputs. This ensures that a step that has just switched off remains off for the set period of time. If a relay output is locked out, all relays with less power are switched on for the duration if required by the sequence controller in order to prevent a total power drop off. Application example: refrigeration machine control

7.6.3 External preselection (IN X)

Maximum selection in case of multiple preselections

You can configure an analog input (IN X) as a preselection for the step switch. The controller performs a maximum selection with the internal signals.

For example, you can use this feature to implement the following function:

External control – the RLU236 provides the step switch function only.

Note

The controller only includes the external signal if it is in the "comfort" or "economy" mode.

7.6.4 Output inversion (INVERS)

Definition and behavior

You can invert the step switch's analog output. Meanings:

INVERS = NO: 0...100 % load = 0...100 % output

INVERS = YES: 0...100 % load = 100...0 % output

The same settings are possible for this analog output as for the modulating output, the AO function block.

If the controller has a binary step switch and is switched off during operation (input D1 = protection mode), the output signal behaves like this:

INVERS = NO: 0 % output

INVERS = YES: 100 % output

7.6.5 Function check / wiring test

Switch ON/OFF

During the wiring test, the step switch can be controlled directly via the control switch.

Switch positions

The switch has the following positions:

- ---
- 0...100 %

Note

Settings such as INVERS, MIN POS and MAX POS are also effective during the wiring test.

Priorities

The following priorities apply to the step switch:

- 1 ON / OFF during the wiring test
- 2 According to the actuating signal from the sequence controller (preselection in normal operation) or an external signal (maximum selection)

7.6.6 Settings

Configuration

Path: ... > **COMMIS** > **CONF** > **STEPBIN**

<i>Display</i>	<i>Name</i>	<i>Range / remark</i>
STEP 1	Step 1	Activates the step switch, and selects the number of steps; adjustable values: ---, Q1, Q2, ... (free outputs only)
STEP 2	Step 2	---, Q1, Q2, ... (free outputs only)
STEP 3	Step 3	---, Q1, Q2, ... (free outputs only)
STEP 4	Step 4	---, Q1, Q2, ... (free outputs only)
AO	Modulating output	---, Y1, Y2, ... (free outputs only)
IN X	Preselection external	---, X1, X2, ... (inputs with identifier % only)

Setting values

Path: ... > **PARA** > **STEPBIN**

<i>Display</i>	<i>Name</i>	<i>Range</i>	<i>Factory setting</i>
OFFTIME	Locking time	00.00...00.10 mm.ss	00.00
MIN POS	Positioning signal min	0...100 %	0 %
MAX POS	Positioning signal max	0...100 %	100 %
INVERS	Inversion	NO, YES	NO

Display values

Path: **CHK**

<i>Display</i>	<i>Name</i>	<i>Remarks</i>
STEPBIN	Binary step switch	0...100%

Wiring test

Path: ... > **COMMIS** > **TEST**

<i>Display</i>	<i>Name</i>	<i>Positions</i>
STEPBIN	Binary step switch	---, 0...100 %

7.7 3-position output (3-POINT)

7.7.1 Purpose and activation

Purpose of 3-POINT

The 3-POINT (3 position output) function block controls a modulating control element (valve) with a 3-position actuator (open/standstill/close). This requires two switch outputs (open/close).

Activation

You can only activate the 3-position output in the RLU222 universal controller. Make the setting "3P" in the configuration menu.

Relays Q1 and Q2 must not be occupied by other functions.

Connection diagram

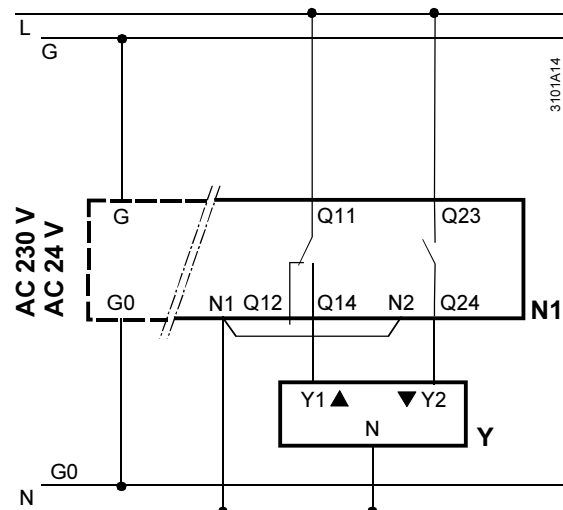

Note

For 3-position control of a control valve with AC 230 V, you must enable the interference suppression feature in the controller. In order to do so, connect terminal N1 to the neutral conductor, and install a bridge between N1 and N2.

7.7.2 Operating principle

Actuating signal calculation

The controller uses the duration of the open and close commands and the defined actuator run time (ACTTIME) to calculate the actuator's present position (stroke model). It compares it with the present positioning setpoint. If the result is a deviation, the controller issues an open or close command.

Synchronization

When the actuator reaches the end positions (fully closed or fully open) the controller synchronizes it with the stroke model (end-position synchronization). In order to do so, the controller issues the appropriate positioning command for a period 1.5 times the defined actuator run time (ACTTIME).

7.7.3 External preselection (IN X)

Maximum selection in case of multiple preselections

You can configure an analog input as a preselection for the 3-position actuator. The controller performs a maximum selection with the internal signals.

For example, you can use this feature to implement the following function: use of the RLU222 universal controller as a DC 0...10 V => 3-position signal converter.

Note

The controller only includes the external signal if it is in the "comfort" or "economy" mode.

7.7.4 Function check / wiring test (TEST)

Switch ON/OFF

During the wiring test, the 3-position output can be directly commanded via the control switch.

Switch positions

The switch has the following positions:

- Standstill (---)
- Open (OPEN)
- Close (CLOS)

Notes

When you enter the commissioning menu (COMMIS) the 3-position actuator travels to the 0 % position (CLOS).

When you leave the COMMIS menu, the controller does not compensate for any changes made to the 3-position output during the wiring test. This does not take place until after the first synchronization.

7.7.5 Priorities

Two priorities

The following two priorities apply to the 3-position output:

- 1 ON / OFF during the wiring test
- 2 According to the actuating signal from the sequence controller (preselection in normal operation) and external preselection (maximum selection)

7.7.6 Settings

Configuration

Path: ... > **COMMIS** > **CONF** > **3-POINT**

<i>Display</i>	<i>Name</i>	<i>Range / remark</i>
3P	3-position	Activates the 3-position output open function; adjustable values: NO, YES
IN X	Preselection external	---, X1, X2, ... (inputs with identifier % only)

Setting values

Path: ... > **PARA** > **3-POINT**

<i>Display</i>	<i>Name</i>	<i>Range</i>	<i>Factory setting</i>
ACTTIME	Actuator run time	10...180 s	120 s

Display values

Path: **CHK**

<i>Display</i>	<i>Name</i>	<i>Remarks</i>
3P	3-position	0...100 %

Wiring test

Path: ... > **COMMIS** > **TEST**

<i>Display</i>	<i>Name</i>	<i>Positions</i>
3P	3-position	---, OPEN, CLOS

8 Controller (CTLOOP x)

8.1 General

8.1.1 Purpose and use

Purpose of CTLOOP x

The CTLOOP x (controller) function block generates an actuating signal based on a comparison of the controlled variable with the selected reference variable in order to control the aggregates assigned to the individual sequences.

Number of controllers

Depending on the type of RLU2... universal controller, the following number of controllers (CTLOOP function blocks) are available:

<i>Device type</i>	<i>Number of controllers</i>
RLU210	Max. 1
RLU222	Max. 1
RLU232	Max. 2
RLU236	Max. 2

Use

We distinguish between Controller 1 and Controller 2.

Controller 1 is used for the following depending on the basic type selected for the device:

<i>Basic type</i>	<i>Use of Controller 1:</i>
A	Ventilation applications: <ul style="list-style-type: none">- Room/supply air temperature cascade controller- Supply air temperature controller- Room temperature controller
U	Universal controller for: humidity, dew point, air quality, pressure, volume flow rate

Controller 2 is used as a universal controller in all basic types.

8.1.2 Controller configuration procedure

Major steps

The controllers are configurable for a wide variety of applications. The following table provides an overview of the major steps with reference to the appropriate chapters:

<i>Step</i>	<i>Activity</i>	<i>Chapter</i>
1	Define the control strategy: What do you want to control and how?	8.2
2	Assign the appropriate outputs to the individual sequences.	8.8
3	Activate the auxiliary functions: <ul style="list-style-type: none">• Limit control, general• Limit control of individual sequences• Locking of sequences according to OT	8.9 8.10 8.11
4	Activate deviation alarming	8.14

8.1.3 Limits and setpoint influences

Influence of functions

The following functions can have an influence on setpoints:

- Summer/winter compensation
- Universal setpoint compensation
- Absolute remote setpoint
- Relative remote setpoint

The setpoint influences differ depending on the selected control strategy. They are described under the various control strategies.

8.1.4 Function priorities

Five priorities

If multiple functions that act on the same controller are active at the same time, the following priorities apply:

- 1 Frost protection FROST
- 2 Locking of sequences according to outside temperature
- 3 Limiting of individual sequence SEQ
- 4 General limit controller (LIM)
- 5 Sequence controller

8.2 Control strategies and setpoints

8.2.1 Setting up the control strategy

Control strategies for Controller 1, basic type A

Controller 1 in basic type A is intended for temperature control. You can choose between a variety of control strategies. In order to do so, you must make the following settings:

<i>Control strategy</i>	<i>Setting value</i>	<i>Setting</i>
Room temperature control See chapter 8.3 (Room temperature must be available)	SUPPLY Xx CAS/CON	--- ROOM Not relevant
Room/supply air temperature cascade control See chapter 8.4 (Room temperature must be available)	SUPPLY Xx CAS/CON	Xx ROOM Xx possible changeover
Supply air temperature control See chapter 8.5 (If the room temperature is not available, the controller automatically operates with constant supply air temperature)	SUPPLY Xx CAS/CON	Xx No ROOM defined Not relevant

Notes

If you do not select a supply air temperature sensor (SUPPLY), the main controlled variable of Controller 1 automatically becomes the room temperature (ROOM).

CAS/CON provides for changeover from cascade control in summer to supply air control in winter (if the heating is ON).

Control strategies for Controller 1, basic type U

The control strategy for Controller 1, basic type U, is the same as the control strategies for Controller 2 (all basic types).

Control strategies for Controller 2

In order to activate the controller, assign the main controlled variable (MAIN).

Controller 2 is usable universally. The choice of main controlled variable determines the physical unit.

You can also use Controller 2 for differential control.

8.2.2 Configuration

Controller 1, basic type A

Path: ... > **COMMIS** > **CONF** > **X1...X5**

<i>Display</i>	<i>Name</i>	<i>Adjustable values / remark</i>
LABEL	Input identifier	Activates the room temperature sensor. Adjustable value: ROOM

Path: ... > **COMMIS** > **CONF** > **CTLOOP 1**

<i>Display</i>	<i>Name</i>	<i>Adjustable values / remark</i>
SUPPLY	Supply air temperature	Activates the supply air temperature sensor. Adjustable values: ---, X1, X2, ... (analog values only)
CAS/CON	Casc/const changeover input	Activates the control strategy. Adjustable values: ---, X1, X2, ... (digital values only). Input signal meanings: 0 = room/supply air cascade control 1 = supply air temperature control (constant)

Controller 1, basic type U Controller 2, all plant types

Path: ... > **COMMIS** > **CONF** > **CTLOOP 1**

Path: ... > **COMMIS** > **CONF** > **CTLOOP 2**

<i>Display</i>	<i>Name</i>	<i>Adjustable values / remark</i>
MAIN	Main controlled variable	Activates the main controlled variable. Adjustable values: ---, X1, X2, ... (analog values only)
DIFF	Differential input	Activates difference control Adjustable values: ---, X1, X2, ... (analog values only)

8.2.3 Application examples

Selection

Typical application examples for various control strategies:

- Room or exhaust air temperature control
- Supply air temperature control
- Room or exhaust air temperature control with supply air limit control
- Room or exhaust air temperature control with supply air cascade control
- Simple heating system with outside temperature compensated supply temperature (without room influence), thermostatic valves
- Differential pressure control
- Cascade control (summer) / supply air temperature control (winter) changeover

8.3 Room temperature control

8.3.1 Activation and setpoints

Activation

Room temperature control is always activated for Controller 1, basic type A. This control process is already active in the device as delivered – you do not have to activate it.

Setpoints

You can assign individual setpoints for the "comfort" and "economy" modes. We distinguish the following setpoints in the two modes:

- SETHEAT lower setpoint "heating" (sequence 1+2)
- SETCOOL upper setpoint "cooling" (sequence 4+5)

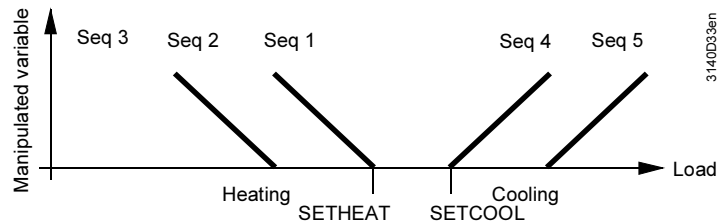

Influences on the setpoints

The following functions can have an influence on setpoints:

- Locking of a sequence according to outside temperature
- Absolute remote setpoint
- Relative remote setpoint
- Summer/winter compensation

8.3.2 Error handling

Room temperature sensor present?

When you leave the commissioning menu, the universal controller checks whether a room temperature sensor is connected to it.

- If a room temperature value is available at that time but is later missing, the controller generates a sensor alarm, and presents it on the display:
"Xx ---" => sensor missing or "Xx 000" => short circuit
- If there is no room temperature value at the time (main controlled variable in this case), the controller switches the plant off (MAINALM):

8.3.3 Settings

Setting values

Path: **SET**

Display	Name	Range	Factory setting
SETCOOL ☾	Economy cooling setpoint	Comfort cooling setpoint to 50 °C	28 °C
SETCOOL ☀	Comfort cooling setpoint	Comfort heating setpoint to economy cooling setpoint	24 °C
SETHEAT ☀	Comfort heating setpoint	Economy heating setpoint to comfort cooling setpoint	21 °C
SETHEAT ☾	Economy heating setpoint	0 °C to comfort heating setpoint	19 °C

Setting heating setpoints above 24 °C – how-to

The heating setpoints are limited by the cooling setpoints. Apply the following procedure to eliminate this limitation:

1. Configure the cooling sequence, i.e. connect with an analog output (AO1, AO2).
2. Raise the cooling setpoints as far as necessary.
3. Set the heating setpoints to the value you want.
4. Remove the configured cooling sequence again.

8.4 Room/supply air temperature cascade controller

8.4.1 Activating the cascade controller

Cascade controller only with Controller 1, basic type A

You can only activate the cascade controller for Controller 1, basic type A. In order to activate the room/supply air temperature cascade controller, assign an input to the supply air temperature (SUPPLY).

Function of the CAS/CON input

If you additionally define a terminal as the CAS/CON input, the input must be "0". You can use this terminal to switch the control strategy between cascade control and supply air control:

- Cascade control CAS/CON = 0
- Supply air temperature control CAS/CON = 1; behavior, see chapter 8.2.1

8.4.2 Operating principle

Principle

This diagram shows the principle of room/supply air temperature cascade control:

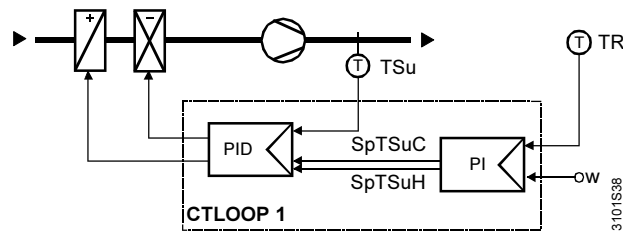

The main controlled variable is the room temperature TR; the auxiliary controlled variable is the supply air temperature TSu. The room temperature controller has PI control action; the supply air temperature controller has PID control action. The result is a PI+PID room/supply air temperature cascade control process.

The room temperature controller sets the present setpoints SpTSuC and SpTSuH for the supply air temperature controller within the selected limit values.

Setpoint derivation

The following diagram shows the setpoint settings for cascade control, and the principle by which the CTLOOP 1 controller block generates the supply air temperature setpoints SpTSuC and SpTSuH:

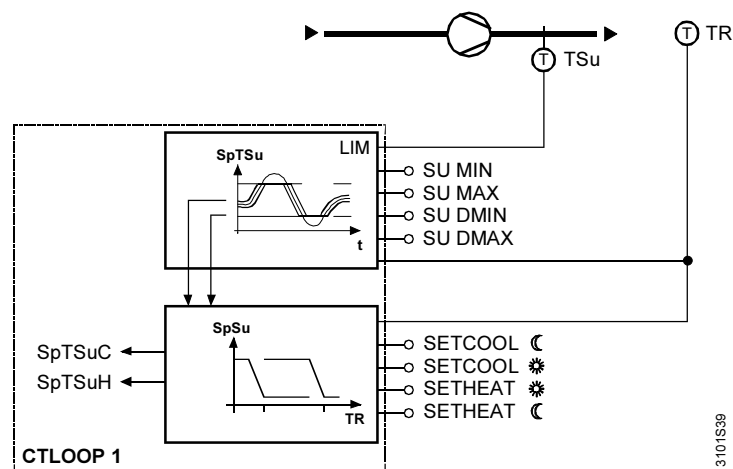

Supply air temperature limit control

The following limit values are preselectable for the supply air temperature controller:

- SU MIN and SU MAX: absolute high and low control of the supply air temperature
- SU DMIN und SU DMAX: high and low temperature difference limit control between the present room temperature value and the supply air temperature

Function diagram

The diagram illustrates the operating principle of the two supply air temperature limit controls:

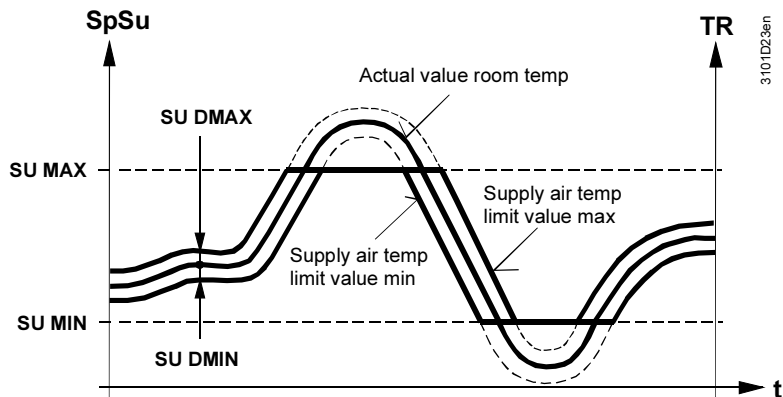

8.4.3 Setpoints

Room temperature setpoints

You can assign individual setpoints in the room temperature controller for the "comfort" and "economy" modes like this:

- SETHEAT lower setpoint "heating" (sequence 1+2)
- SETCOOL upper setpoint "cooling" (sequence 4+5)

Influences

These functions can have an influence on setpoints:

- Locking of a sequence according to outside temperature
- Absolute remote setpoint
- Relative remote setpoint
- Summer/winter compensation

8.4.4 Error handling

Room temperature sensor present?

When you leave the commissioning menu, the universal controller checks whether a room temperature sensor is connected to it, and it reacts like this:

- If a room temperature measured value is available at that time but is later missing, the controller generates a sensor alarm, and presents it on the display:
 - "Xx ---" => sensor missing
 - "Xx ooo" => short circuit
- If a room temperature measured value is not available at that time, the supply air is controlled according to the defined room temperature setpoints.

8.4.5 Settings

Setting values

Path: ... > **PARA** > **CTLOOP 1**

<i>Display</i>	<i>Name</i>	<i>Range</i>	<i>Factory setting</i>
ROOM XP	Room influence Xp	0.5...999.9 K	10 K
ROOM TN	Room influence Tn	00.00...60.00 mm.ss	10.00 m.s
SU MAX	Supply air limit value max	-50...+250 °C	35 °C
SU MIN	Supply air limit value min	-50...+250 °C	16 °C
SU DMIN	Min limitation supply air delta	0...50 K	50 K
SU DMAX	Max limitation supply air delta	0...50 K	50 K

Path: ... > **SET**

<i>Display</i>	<i>Name</i>	<i>Range</i>	<i>Factory setting</i>
SETCOOL ☞	Economy cooling setpoint	Comfort cooling setpoint to 50 °C	28 °C
SETCOOL ☼	Comfort cooling setpoint	Comfort heating setpoint to economy cooling setpoint	24 °C
SETHEAT ☼	Comfort heating setpoint	Economy heating setpoint to comfort cooling setpoint	21 °C
SETHEAT ☞	Economy heating setpoint	0 °C to comfort heating setpoint	19 °C

8.4.6 Application example

Plant diagram

The example shown in the following is the programmed standard application with controller type RLU222, basic type A16, for a plant with a hot-water air heater and chilled water air cooler. Functions:

- Room temperature cascade control
- Summer/winter compensation
- Frost protection
- Fan release

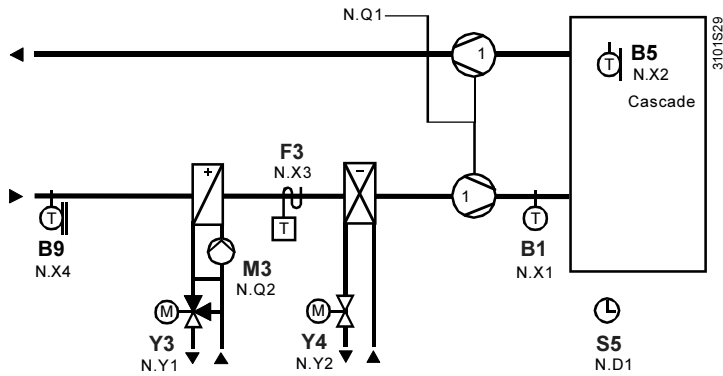

Function diagrams

Controller sequences:

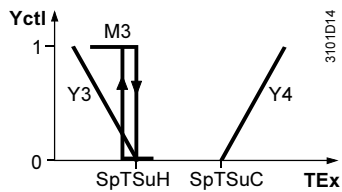

Preselected setpoints for supply air temperature control:

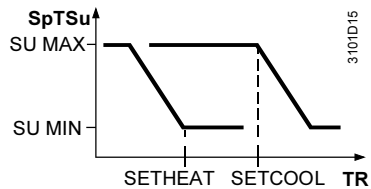

Summer/winter compensation:

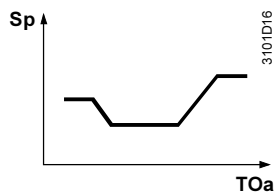

8.5 Supply air temperature control

8.5.1 Activating the supply air temperature control process

Activation for Controller 1, basic type A only

You can only activate the supply air temperature control process for Controller 1, basic type A.

In order to activate supply air temperature control, assign an input to the supply air temperature sensor (SUPPLY).

8.5.2 Operating principle

PID control

A PID control process controls the supply air temperature according to the defined setpoint.

8.5.3 Setpoints

Preselections

You can assign individual supply air temperature control setpoints for the "comfort" and "economy" modes like this:

- SETHEAT lower setpoint "heating" (sequence 1+2)
- SETCOOL upper setpoint "cooling" (sequence 4+5)

Influences on the setpoints

The following functions can influence the supply air (or room) temperature setpoints:

- Locking of a sequence according to outside temperature
- Absolute remote setpoint
- Relative remote setpoint
- Summer/winter compensation

The defined high and low-limit control values for the supply air temperature have no effect.

8.5.4 Error handling

Supply air temperature sensor present?

When you leave the commissioning menu, the universal controller checks whether a supply air temperature sensor is connected to it, and it reacts like this:

- If the supply air temperature sensor is connected at that time but is later missing, the controller generates a sensor alarm, and presents it on the display:
 - "Xx ---" => sensor missing
 - "Xx 000" => short circuit
- If there is no supply air temperature sensor (main controlled variable in this case) from the start, the controller switches the plant off (MAINALM):

8.5.5 Settings

Setting values

Path: ... > **PARA** > **CTLOOP 1**

<i>Display</i>	<i>Name</i>	<i>Range</i>	<i>Factory setting</i>
SU MAX	Supply air limit value max	-50...+250 °C	35 °C
SU MIN	Supply air limit value min	-50...+250 °C	16 °C

Path: ... > **SET**

<i>Display</i>	<i>Name</i>	<i>Range</i>	<i>Factory setting</i>
SETCOOL ☾	Economy cooling setpoint	Comfort cooling setpoint ... 50 °C	28 °C
SETCOOL ☀	Comfort cooling setpoint	Comfort heating setpoint ... economy cooling setpoint	24 °C
SETHEAT ☀	Comfort heating setpoint	Economy heating setpoint ... comfort cooling setpoint	21 °C
SETHEAT ☾	Economy heating setpoint	0 °C ... comfort heating setpoint	19 °C

8.6 Universal controller

8.6.1 Activation and application

Activation

You can activate this control function for Controller 1, basic type U, and for Controller 2, all basic types. In order to activate the controller, assign an input to the main controlled variable.

Application

The universal controller can control according to an absolute value or a differential value. In the case of differential control, the controlled variable is:
main controlled variable (MAIN) – differential input (DIFF)

Example: chilled ceiling
(absolute value)

The chilled ceiling's supply temperature is controlled according to an absolute value:

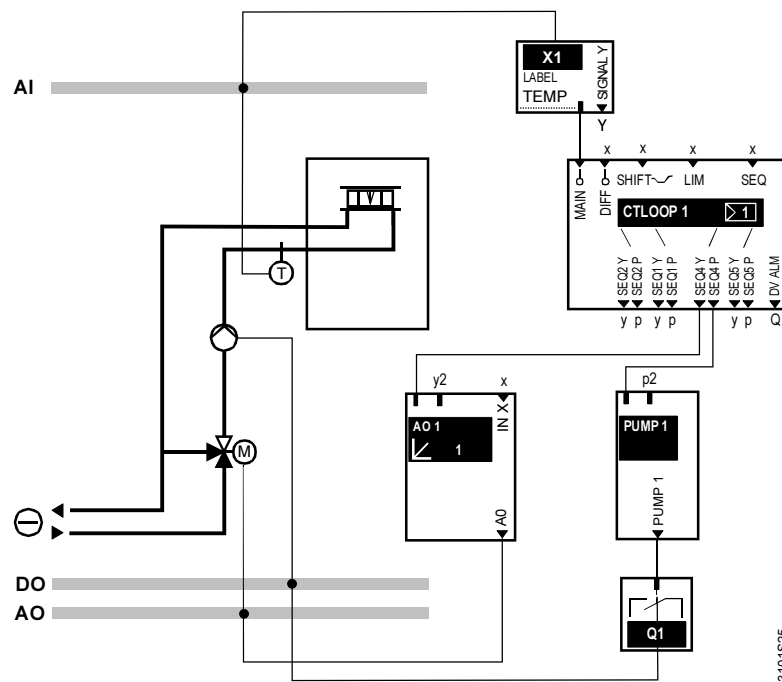

Example: solar plant
(differential value)

The solar plant switches on as soon as the temperature in the panel (main controlled variable) is 5 K above the storage tank temperature (differential controlled variable):

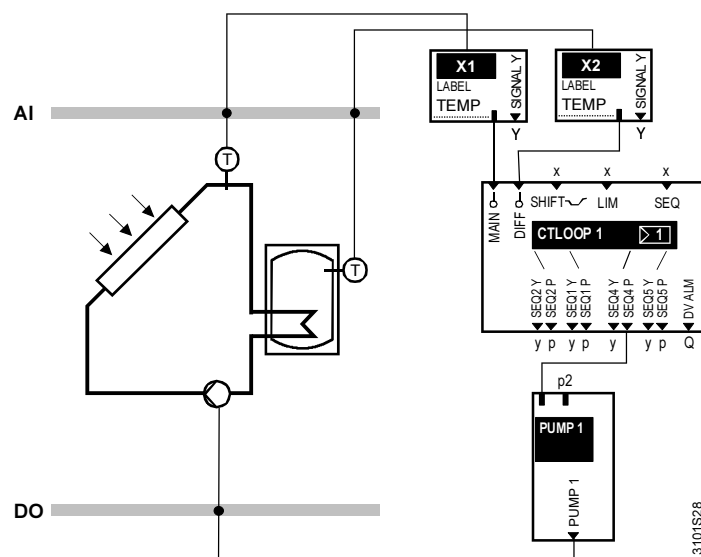

Settings

The following settings are required depending on the desired function:

<i>Desired control process</i>	<i>Setting</i>	<i>Value</i>
Control to a sensor input	Main controlled variable (MAIN)	Xx (analog)
	Differential input(DIFF)	---
Differential control	Main controlled variable (MAIN)	Xx (analog)
	Differential input (DIFF)	Xx (same unit as main controlled variable)

8.6.2 Operating principle

PID control

A PID control process controls the main controlled variable according to the defined setpoint.

8.6.3 Setpoints

Preselections

The following applies to Controller 2, basic type A, and Controller 1+2, basic type U:

- You can assign individual setpoints for the "comfort" and "economy" modes.
- We distinguish between the following setpoints:
 - SETHEAT lower setpoint "heating" (sequence 1+2)
 - SETCOOL upper setpoint "cooling" (sequence 4+5)

Influences on the setpoints

These functions can have an influence on setpoints:

- Universal setpoint compensation
- Absolute remote setpoint

8.6.4 Error handling

Effect of incorrect configuration

Incorrect configuration has the following effect:

<i>Configuration point</i>	<i>Setting</i>	<i>Type of action</i>
Main controlled variable (MAIN) Differential input (DIFF)	--- (not relevant)	Controller inactive
Main controlled variable (MAIN) Differential input (DIFF)	Xx (analog) Xx (not the same unit as main controlled variable)	Control to an absolute value, not differential control

Main sensor present?

When you leave the commissioning menu, the universal controller checks whether a main sensor is connected to it.

- If the main sensor is connected at that time but is later missing, or if there is a short circuit in the cable, the controller generates a sensor alarm and presents it on the display:
 - "Xx ---" => main sensor missing
 - "Xx ooo" => short circuit
- If there is no main sensor at the time (main controlled variable in this case), the controller switches the plant off (MAINALM):

8.6.5 Settings

Controller 1, basic type U

Path: ... > SET

<i>Display</i>	<i>Name</i>	<i>Range</i>	<i>Factory setting</i>
SET MAX ☒	Economy setpoint high	Main controlled variable input range	28 °C, 80 %, 100, 1000
SET MAX ☀	Upper comfort setpoint	Main controlled variable input range	24 °C, 60 %, 6, 400
SET MIN ☀	Lower comfort setpoint	Main controlled variable input range	21 °C, 40 %, 0, 0
SET MIN ☒	Economy setpoint bottom	Main controlled variable input range	19 °C, 20 %, 0, 0

Controller 2, basic types A and U

Path: ...> SET

<i>Display</i>	<i>Name</i>	<i>Range</i>	<i>Factory setting</i>
SET MAX ☒	Economy setpoint high	Main controlled variable input range	28 °C, 80 %, 100, 1000
SET MAX ☀	Upper comfort setpoint	Main controlled variable input range	24 °C, 60 %, 6, 400
SET MIN ☀	Lower comfort setpoint	Main controlled variable input range	21 °C, 40 %, 0, 0
SET MIN ☒	Economy setpoint bottom	Main controlled variable input range	19 °C, 20 %, 0, 0

8.7 Primary controller (universal) with changeover

8.7.1 Activating the universal controller with changeover

Plant principle

The following example shows a changeover plant with supply area, primary control and room temperature controls. The RLU2...(U) primary controller and RLU2...(A) room temperature controller are indicated.

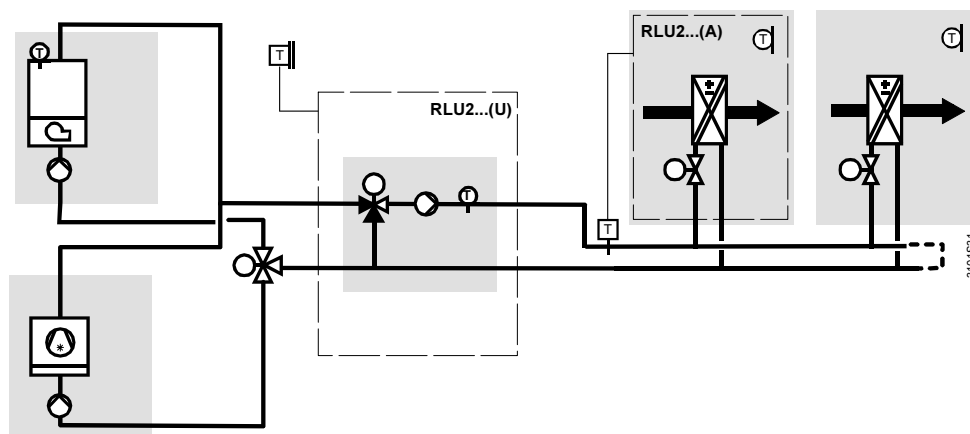

Activating the RLU2...(U) primary controller

You can activate this control function for all universal controllers, i.e. for RLU210, RLU222, RLU232 and RLU236 in basic type U.

Apply the following procedure to activate the respective controller:

- Assign one Xx input each to the main controlled variable (MAIN) at the CTLOOPx controller block and to the CH OVER input at the MODE function block.
- Set the identifier of the main controlled variable (MAIN) to TEMP.

Note: The "Changeover" function always acts on Controller 1 only.

Room temperature controller RLU210 (A)

It is also possible to activate the changeover function in the RLU210 controller, basic type A:

The RLU210 controller operates as a normal room temperature controller, basic type A. However, the changeover input, which is switched by a changeover thermostat on the supply side, enables only the heating or cooling sequence at any one time.

8.7.2 Operating principle

Control type

A PID control process controls the main controlled variable according to the defined setpoint.

Sequence enabling

The position of the CH OVER digital input determines whether the heating sequence or cooling sequence is enabled:

- CH OVER = 0 signifies "enable cooling sequences"
- CH OVER = 1 signifies "enable heating sequences"

Note

The "analog output" aggregate must be configured for sequences, i.e.:

- Heating (sequence 1) and
- Cooling (sequence 4)

See chapter 8.8 Sequence Controllers, Output Assignments for more information.

8.7.3 Setpoints

Basic type U, Controller 1

You can assign individual setpoints for the "comfort" and "economy" modes.

We distinguish between the setpoints for:

- Primary controller "heating" (sequence 1)
- Primary controller "cooling" (sequence 4)

Setpoint preselection

The following diagrams illustrate the different setpoint preselections for non-changeover systems and changeover systems:

Non-changeover system:

Heating setpoints less than cooling setpoints
e.g. room temperature control

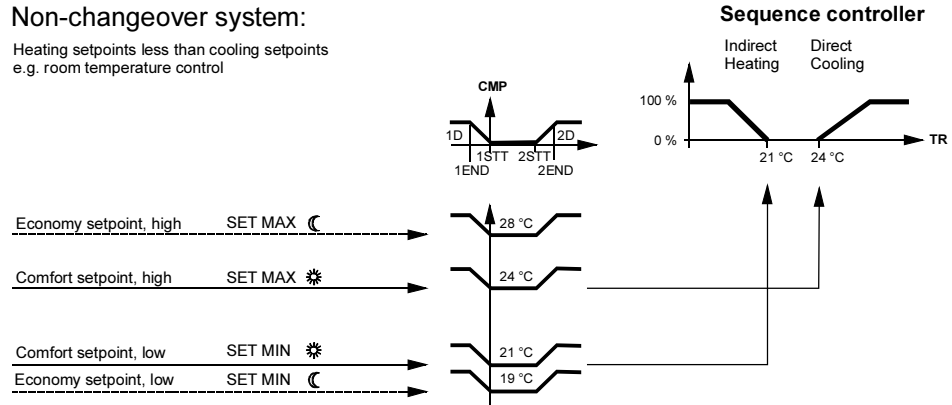

Changeover system:

Heating setpoints greater than cooling setpoints
e.g. supply temperature control

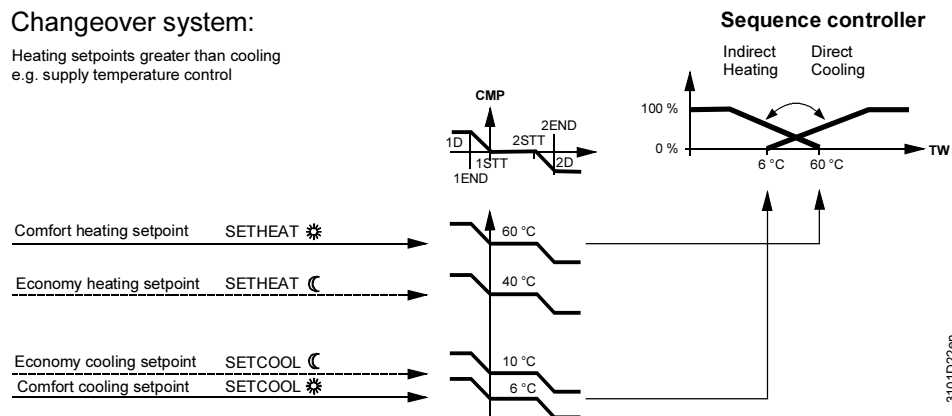

Refer to the corresponding setting values on the following page (factory settings).

Note on economy setpoints

Economy setpoints are only adjustable if an input has been defined for mode changeover.

Influences on the setpoints

The following functions can have an influence on setpoints:

- Universal setpoint compensation (see page 91)
- Absolute remote setpoint (see page 29)

Basic type U, Controller 2

Sequence controller 2 always operates in the same mode as sequence controller 1, but it has no changeover functionality.

8.7.4 Error handling

Main sensor present?

When you leave the commissioning menu, the universal controller checks whether a main sensor is connected to it.

- If the main sensor is connected at that time but is later missing, or if there is a short circuit in the cable, the controller generates a sensor alarm and presents it on the display:
 - "Xx ---" => main sensor missing
 - "Xx 000" => short circuit
- If there is no main sensor at the time (main controlled variable in this case), the controller switches the plant off (MAINALM):

8.7.5 Settings

Configuration

Path: ... > **COMMIS** > **CONF** > **MODE**

<i>Display</i>	<i>Name</i>	<i>Adjustable values / remark</i>
CH OVER	2-pipe heating/cooling system	Activates the heating/cooling changeover contact. Adjustable values: ---, X1, X2, ... (digital values only)

Setting values

Path: ... > **SET**

<i>Display</i>	<i>Name</i>	<i>Range</i>	<i>Factory setting</i>	
			<i>Non-changeover</i>	<i>Changeover</i>
SETCOOL ☺	Economy cooling setpoint	0...100 °C	28 °C	10 °C
SETCOOL ☼	Comfort cooling setpoint	0...100 °C	24 °C	6 °C
SETHEAT ☼	Comfort heating setpoint	0...100 °C	21 °C	60 °C
SETHEAT ☺	Economy heating setpoint	0...100 °C	19 °C	40 °C

Display values

Path: **CHK**

<i>Display</i>	<i>Name</i>	<i>Remarks</i>
CH OVER	2-pipe heating/cooling system	Present COOL / HEAT state

8.8 Sequence controllers, output assignments

8.8.1 Activating the function block

Assign the main controlled variable

In order to activate the sequence controller CTLOOPx, assign a main controlled variable to it. The necessary settings are described in chapter 8.2 Setting up the Control Strategy.

8.8.2 Structure of the sequence controller

Controller 1 RLU232, RLU236

Controller 1 (in RLU232 and RLU236) can contain a maximum of 4 sequences in the following combinations:

- One sequence: sequence 1 or sequence 4
- Two sequences: sequence 1+2, or sequence 1+4, or sequence 4+5
- Three sequences: sequence 1+2+4, or sequence 1+4+5
- Four sequences: sequence 1+2+4+5

Function diagram

The following diagram shows the sequences and their directions of action:

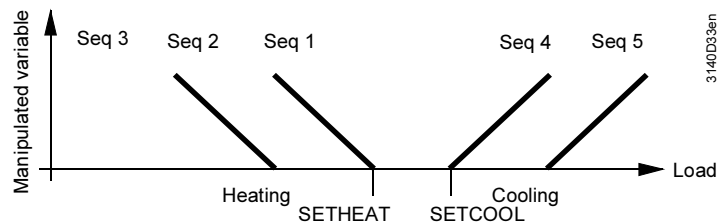

Explanations about the function diagram

The SETHEAT heating setpoint is assigned to successive sequences 1 and 2. Their output signal acts in the opposite direction to the input variable (temperature T). The SETCOOL cooling setpoint is assigned to successive sequences 4 and 5. Their output signal acts in the same direction as the input variable (temperature T).

RLU210, RLU222

Similar to the above statements, the RLU210 and RLU222 controllers contain a single controller with the following sequences:

- RLU210 no more than 1 sequence _ or _ /
- RLU222 up to 3 sequences _ or _ // or _ _ / or _ _ /

Controller 2 RLU232, RLU236

Controller 2 (in RLU232 and RLU236 only) can contain a maximum of 2 sequences in the following combinations:

- One sequence: sequence 1 or sequence 4
- Two sequences: sequence 1+2, or sequence 1+4

Function diagram

The following diagram shows the sequences and their directions of action:

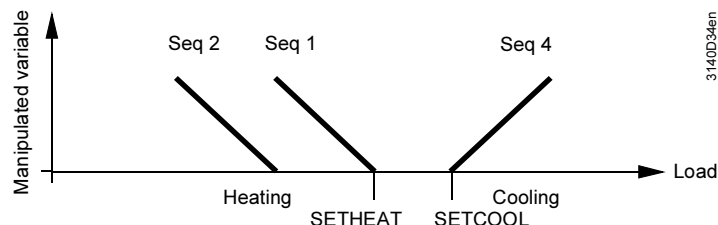

8.8.3 Assignment of outputs to sequences

Outputs Y and P

Each sequence has 2 outputs:

- 1 load output SEQx Y
- 1 pump output SEQx P

You can occupy both.

8.8.4 Activating the sequences

Activation rules

In order to activate a sequence, assign either a load output or a pump output to it. If neither the one nor the other is assigned to a sequence, that sequence and all subsequent sequences are inactive.

8.8.5 Load outputs

Available load outputs

The following load outputs are available for the sequence controllers:

- Modulating output
- Heat recovery unit / mixing damper
- Variable step switch
- Linear step switch
- Binary step switch
- 3-position output

Load output rules

Only **one** load output can be assigned to each sequence.

However, each load output can be commanded by up to two sequences (from the same or different control loops).

Application example

This example shows a plant with the heating, cooling and dehumidification functions.

Associations:

- Control loop 1 (room temperature) with sequence 1 (heating) and sequence 4 (cooling)
- Control loop 2 (room humidity) with sequence 4 (dehumidification)
- Both controllers (sequences 4) command load output AO2, which transmits the resultant signal to the air cooler valve via output Y2.

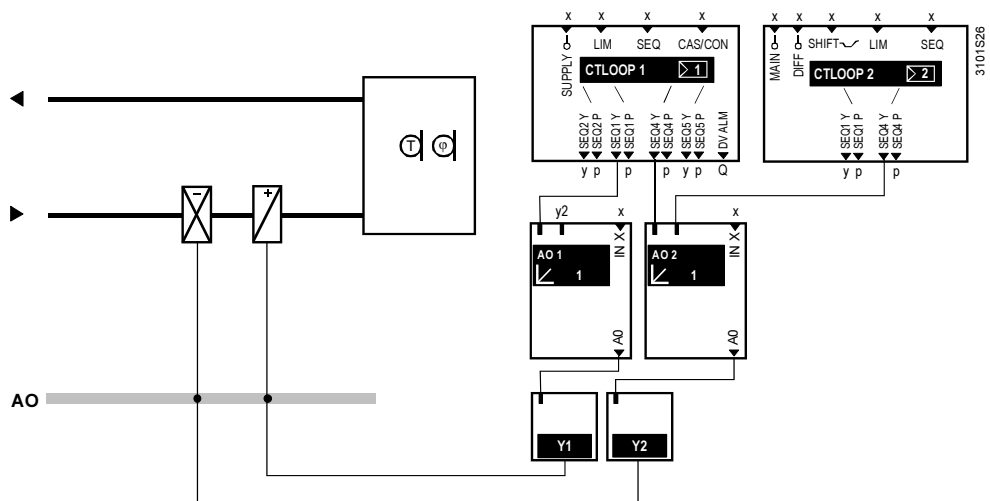

8.8.6 Pump outputs

Possibilities

Only one pump can be assigned to each sequence. However, each pump can be commanded by up to two sequences.

Application example

This example shows an air heater with a valve and pump. Both are commanded by sequence 1; the pump is commanded via the pump output SEQ2 P:

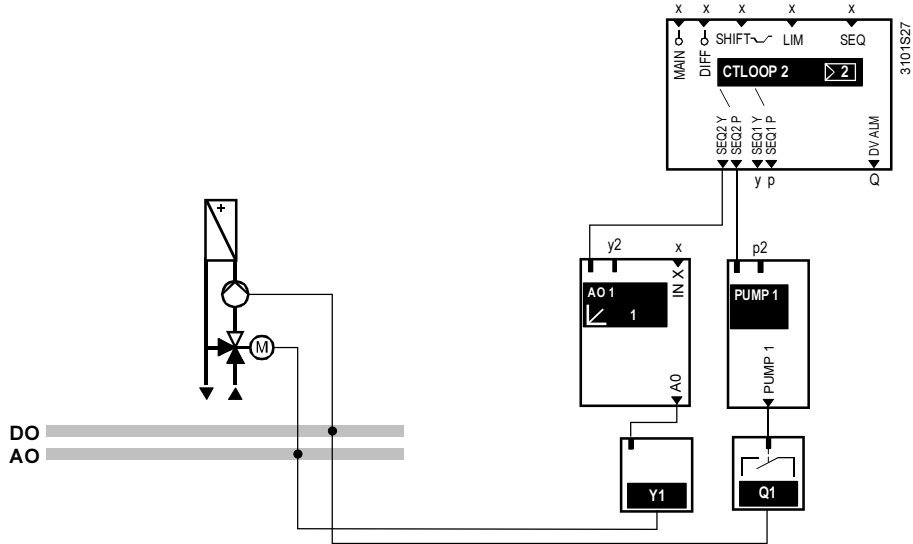

8.8.7 Control parameters (Xp, Tn, Tv)

Setting possibilities

You can define the following control parameters for each configured sequence:

- SEQx XP (P-band Xp)
- SEQx TN (Integral-action time Tn)
- SEQx TV (Derivative-action time Tv)

If you use all parameters, the result is a PID control loop.

If you want P, PI or PD control action, make the following settings:

Setting	Result
SEQx TN = 00:00; SEQx TV = 00:00	P action
SEQx TV = 00:00	PI action
SEQx TN = 00:00	PD action

Recommendations for commissioning

We recommend the following standard values for quick controller commissioning:

- P-band Xp of the controller:
Room and exhaust air control loops 1...2 K / 2...4 % r.h.,
supply air control loops 5 K / 10 % r.h.
- Set the integral-action time Tn equal to the greatest time constant of the controlled system.
- Set the derivative-action time Tv equal to the time constant of the sensor.

Apply the following procedure if the control loop oscillates:

1. Set Tn and Tv to 00:00.
2. Increase Xp (e.g. double it)
3. Add Tn again, starting with the value shown above.
Increase Tn if the control loop starts to oscillate again.
4. Add Tv again, starting with the value shown above.
Reduce Tv if the control loop starts to oscillate again.

8.8.8 Control timeout

Delays the integral-action component

In order, for example, to prevent the cooling valve from opening immediately that the heating valve closes, you can define a control timeout period (TIMEOUT). The controller does not add the integral-action component during that period.

8.8.9 Error handling

Errors in operation

If the main controlled variable is not available to the controller (e.g. in case of cable failure) it switches the plant OFF and generates a sensor error message "Xx ---" or "Xx ooo".

Configuration errors

The major configuration errors and their consequences are listed here:

- The sequence controller only operates if a terminal with an analog value is assigned to its main controlled variable.
- If individual sequences do not have outputs assigned to them, they and all subsequent sequences are inactive. The possible combinations are described in chapter 8.8.2 Structure of the Sequence Controller.
- You cannot assign more than 2 sequences.

8.8.10 Settings

Configuration

Path: ... > **COMMIS > CONF > CTLOOP 1**

... > **COMMIS > CONF > CTLOOP 2**

<i>Display</i>	<i>Name</i>	<i>Range / remark</i>
SEQ1 Y	[Sequence 1] load	---, modulating output 1...3, heat recovery unit, variable step switch 1...2, linear step switch, binary step switch
SEQ1 P	[Sequence 1] pump	---, pump 1...3

Path: ... > **COMMIS > CONF > CTLOOP 1**

<i>Display</i>	<i>Name</i>	<i>Range / remark</i>
SEQ2 Y	[Sequence 2] load	---, modulating output 1...3, heat recovery unit, variable step switch 1...2, linear step switch, binary step switch
SEQ2 P	[Sequence 2] pump	---, pump 1...3

Path: ... > **COMMIS > CONF > CTLOOP 1**

... > **COMMIS > CONF > CTLOOP 2**

<i>Display</i>	<i>Name</i>	<i>Range / remark</i>
SEQ4 Y	[Sequence 4] load	---, modulating output 1...3, variable step switch 1...2, linear step switch, binary step switch
SEQ4 P	[Sequence 4] pump	---, pump 1...3

Path: ... > **COMMIS > CONF > CTLOOP 1**

<i>Display</i>	<i>Name</i>	<i>Range / remark</i>
SEQ5 Y	[Sequence 5] load	---, modulating output 1...3, variable step switch 1...2, linear step switch, binary step switch
SEQ5 P	[Sequence 5] pump	---, pump 1...3

Configuration note

The configuration shown above is designed for a RLU236 controller, but different aggregates are available with each type; see chapter 1.4, Functions.

Setting values

Path: ... > **PARA** > **CTLOOP 1**
 ... > **PARA** > **CTLOOP 2**

<i>Display</i>	<i>Name</i>	<i>Range</i>	<i>Factory setting</i>
SEQ1 XP	[Sequence 1 _] Xp	0...500 K	30 K
SEQ1 TN	[Sequence 1 _] Tn	00.00...60.00 m.s	03.00 m.s
SEQ1 TV	[Sequence 1 _] Tv	00.00...60.00 m.s	00.00 m.s
SEQ2 XP	[Sequence 2 \.._] Xp	0...500 K	30 K
SEQ2 TN	[Sequence 2 \.._] Tn	00.00...60.00 m.s	03.00 m.s
SEQ2 TV	[Sequence 2 \.._] Tv	00.00...60.00 m.s	00.00 m.s
SEQ4 XP	[Sequence 4 _/] Xp	0...500 K	30 K
SEQ4 TN	[Sequence 4 _/] Tn	00.00...60.00 m.s	03.00 m.s
SEQ4 TV	[Sequence 4 _/] Tv	00.00...60.00 m.s	00.00 m.s
SEQ5 XP	[Sequence 5 _.. /] Xp	0...500 K	30 K
SEQ5 TN	[Sequence 5 _.. /] Tn	00.00...60.00 m.s	03.00 m.s
SEQ5 TV	[Sequence 5 _.. /] Tv	00.00...60.00 m.s	00.00 m.s
TIMEOUT	Control timeout	00.00...60.00 m.s	00.00 m.s

Display values

Path: **Info**

<i>Display</i>	<i>Name</i>	<i>Remarks</i>
_	[Sequence 1] load output	Indicates the sequence controller's present output as 0...100 % with a sequence diagram and controller icon
\ _	[Sequence 2] load output	See above remark
_ /	[Sequence 4] load output	See above remark
_ _ / /	[Sequence 5] load output	See above remark

8.9 Limit control, general (LIM)

8.9.1 Purpose and activation

Purpose of LIM

The LIM function (general limit controller) overrides the sequence controller's normal control function.

Activation

In order to activate the function, you have to assign an input Xx to the LIM connection of the CTLOOP function block.

If other influences act on the sequence controller at the same time, the order of priorities applies as shown in chapter 8.1.4, Function Priorities.

8.9.2 Operating principle

Limit controller with PI response

If a controlled variable goes above or below the limit setpoint, the limit controller overrides the normal control function with a PI response (LIM XP, LIM TN) to ensure compliance with the limit setpoint. We distinguish between:

- Absolute limit control
- Relative limit control

If you only want one of these functions, you can disable the other by setting the setpoints a long way out of range.

Absolute limit control

You can define one setpoint each for high-limit and low-limit control (LIM MAX, LIM MIN).

Application example

Supply air temperature or supply air humidity limit control:

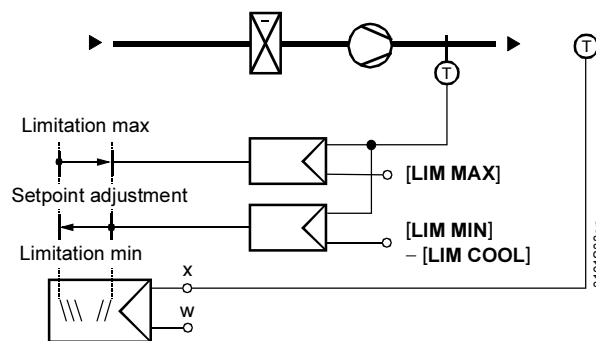

Acts on all sequences

!! Not meaningful with cascade control !!

Special case: Cooling sequence 4+5 active

If cooling sequence 4+5 is enabled, the low-limit control can be set lower by an adjustable value (LIMCOOL). This feature prevents the refrigeration machine from switching off again shortly after switching on in case of stepped (DX) cooling. It is only active if the main controlled variable and the general limit control input have the unit °C.

Relative limit control

The following applies to relative limit control:

- You can only activate high and low differential limit control (LIM DHI, LIM DLO) if the main controlled variable and limit control sensor are configured with the same physical unit.
- The defined limit control setpoints refer to the temperature difference between the main controlled variable and the limit control sensor.
- You can define one setpoint each for high-limit and low-limit differential temperature control.

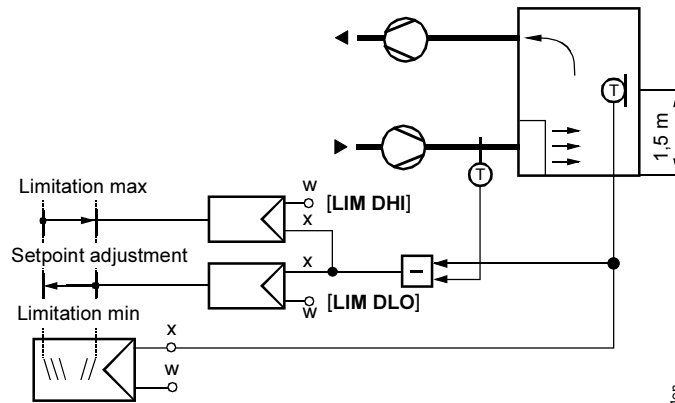

Acts on all sequences
 !! Not meaningful with cascade control !!

310/S34en

8.9.3 Error handling

Limit control sensor connected?

When you leave the commissioning menu, the universal controller checks whether a sensor is connected to the LIM input.

- If a sensor is connected at that time but is later missing, the controller generates a sensor alarm, and presents it on the display:
 - "Xx ---" => sensor missing
 - "Xx 000" => short circuit
- If no sensor is connected at the time, the limit control function is disabled.

8.9.4 Settings

Configuration

Path: ... > **COMMIS** > **CONF** > **CTLOOP 1**
 ... > **COMMIS** > **CONF** > **CTLOOP 2**

Display	Name	Range / remark
LIM	General limit controller	Activates general limit control; adjustable values: ---, X1, X2, ... (analog values only)

Setting values

Path: ... > **PARA** > **CTLOOP 1**
 ... > **PARA** > **CTLOOP 2**

Display	Name	Range	Factory setting
LIM MAX	Gen limiter limit value high	Limit control sensor input range	35 °C
LIM MIN	Gen limiter limit value low	Limit control sensor input range	16 °C
LIM DHI	Gen limiter differential high	0...100 K	50 K
LIM DLO	Gen limiter differential low	0...100 K	50 K
LIMCOOL	Reduction min limitation cooling	0...10 K	0 K
LIM XP	Gen limiter P-band Xp		15 K
LIM TN	Gen limiter integr action time Tn	00.00...60.00 m.s	02.00 m.s

8.10 Limit control of individual sequences (SEQ)

8.10.1 Purpose and activation

Purpose of SEQ

The SEQ provides limit control for individual sequences.

Activation

In order to activate this function, configure the SEQ input of the CTLOOP controller. The following applies:

- You can only assign analog inputs.
- You can only activate this function once per controller.
- If other influences act on the sequence controller at the same time, the order of priorities applies as shown in chapter 8.1.4, Function Priorities.

8.10.2 Operating principle

General function

This function is configurable either for low-limit control or for high-limit control. You can assign its action to one of the sequences (Seq 1, Seq 2, ... Seq 5):

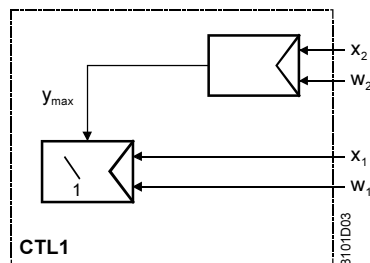

Legend:

X_2	Limit controlled variable
W_2	Limit control setpoint (min/max)
y_{max}	Limit control signal; always acts in close direction on 1 sequence (Seq1, Seq2...Seq5)
X_1	Main controlled variable
W_1	Main setpoint
CTL1	Controller 1 (CTLOOP1)

Low-limit control

If a controlled variable goes below the limit control setpoint (SEQ SET), the limit controller overrides the normal control function with a PI response (SEQ XP, SEQ TN) to ensure compliance with the limit setpoint.

The low-limit control acts in the close direction on the respective sequences; it has no effect on the other sequences.

Application example, HRU

Frost protection for a heat recovery unit (HRU), acting in close direction on sequence 1 (Y6)

The temperature at limit control sensor B21 must, for example, be at least 0 °C (SEQ SET), otherwise throughput will be steplessly limited by Y6.

Pictorial schematic

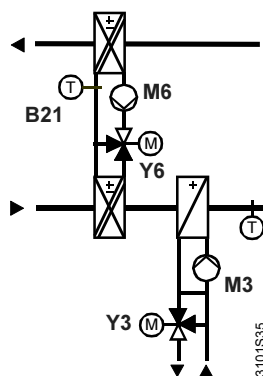

Function diagram

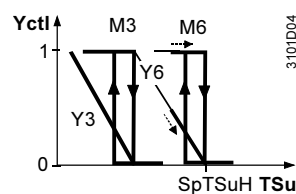

Application example,
boiler

Low-limit control of the water inlet temperature (B7) in a boiler with corrosion risk, acting on sequence 1 (Y3):

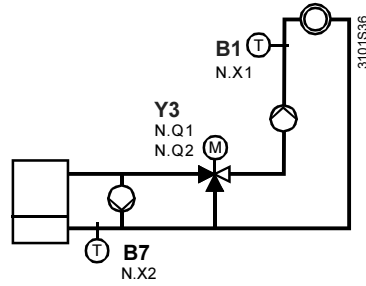

High-limit control

If a controlled variable goes above the limit control setpoint (SEQ SET), the limit controller overrides the normal control function with a PI response (SEQ XP, SEQ TN) to ensure compliance with the limit setpoint.

The high-limit control function acts in the close direction on the sequences.

Application example,
air heater

High-limit control of the return temperature (TRL), acting on sequence 1 / valve M:

Pictorial schematic

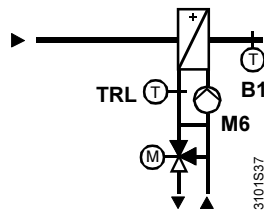

Function diagram

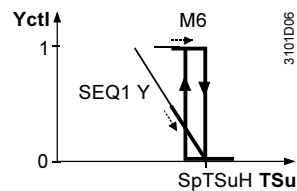

8.10.3 Error handling

Sensor connected?

When you leave the commissioning menu, the universal controller checks whether a sensor is connected to it.

- If the sensor is connected at that time but is later missing, or if there is a short circuit in the cable, the controller generates a sensor alarm and presents it on the display:
 - "Xx ---" => sensor missing
 - "Xx ooo" => short circuit
- If the sensor is not connected at the time, the limit control function is disabled.

8.10.4 Settings

Configuration

Path: ... > **COMMIS** > **CONF** > **CTLOOP 1**
 ... > **COMMIS** > **CONF** > **CTLOOP 2**

<i>Display</i>	<i>Name</i>	<i>Range / remark</i>
SEQ	Sequence limit controller	Activates the limit control of an individual sequence; adjustable values: ---, X1, X2, ... (analog values only)

Setting values

Path: ... > **PARA** > **CTLOOP 1**
 ... > **PARA** > **CTLOOP 2**

<i>Display</i>	<i>Name</i>	<i>Range</i>	<i>Factory setting</i>
SEQ MOD	Type of limitation	Min, Max	Min
SEQ SEL	Sequence selection	Seq1, Seq2, Seq4, Seq5	Seq1
SEQ SET	Limit value	Input signal range	1 °C
SEQ XP	Seq limiter P-band Xp	Input signal range	10 K
SEQ TN	Seq limiter integr action time Tn	00.00...60.00 mm.ss	02.00 m.s

8.11 Locking of sequences according to outside temperature

8.11.1 Purpose and activation

Purpose

This function disables individual sequences depending on the outside temperature.

Activation

This function is always active if an outside temperature value is available. If other influences act on the sequence controller at the same time, the order of priorities applies as shown in chapter 8.1.4, Function Priorities.

8.11.2 Operating principle

Summer and winter cases

You can lock heating sequences at a higher outside temperature and cooling sequences at a lower outside temperature. This ensures that heating is deactivated in summer and cooling is deactivated in winter. The switching differential is fixed at 2 K

Summer:

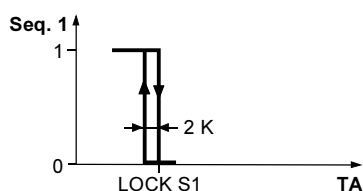

Winter:

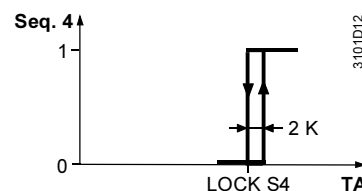

Explanation

1 = sequence enabled
0 = sequence disabled

Response if individual sequences are disabled

If individual sequences are disabled, the controller continues its action with the other sequences without a transition. If, for example, sequence 1 is disabled, then the controller uses sequence 2 for heating (sequence 1 does not delay the control process).

8.11.3 Error handling

OT sensor signal available?

If there is no outside temperature sensor signal, the controller does not disable the sequences.

8.11.4 Settings

Setting values

Path: ... > PARA > CTLOOP 1
... > PARA > CTLOOP 2

Display	Name	Range	Factory setting
LOCK S1	[Sequence 1] outside temp >	-50...+250 °C	250 °C
LOCK S2	[Sequence 2] outside temp >	-50...+250 °C	250 °C
LOCK S4	[Sequence 4] outside temp <	-50...+150 °C	-50 °C
LOCK S5	[Sequence 5] outside temp <	-50...+150 °C	-50 °C

8.11.5 Application example

Preheater

Disable a preheater on sequence 2 at temperatures above 10 °C. Function: valve closed, pump off

8.12 Summer/winter compensation

8.12.1 Activation

Controller 1, basic type A

The summer/winter compensation function is only enabled for Controller 1, basic type A. It is always active if an outside temperature signal is available.

8.12.2 Operating principle

Function

This function adjusts the room temperature controller's setpoint as a function of the outside temperature.

Diagram

This setpoint compensation function acts on the "comfort" mode and the reduced setpoint according to the following diagram:

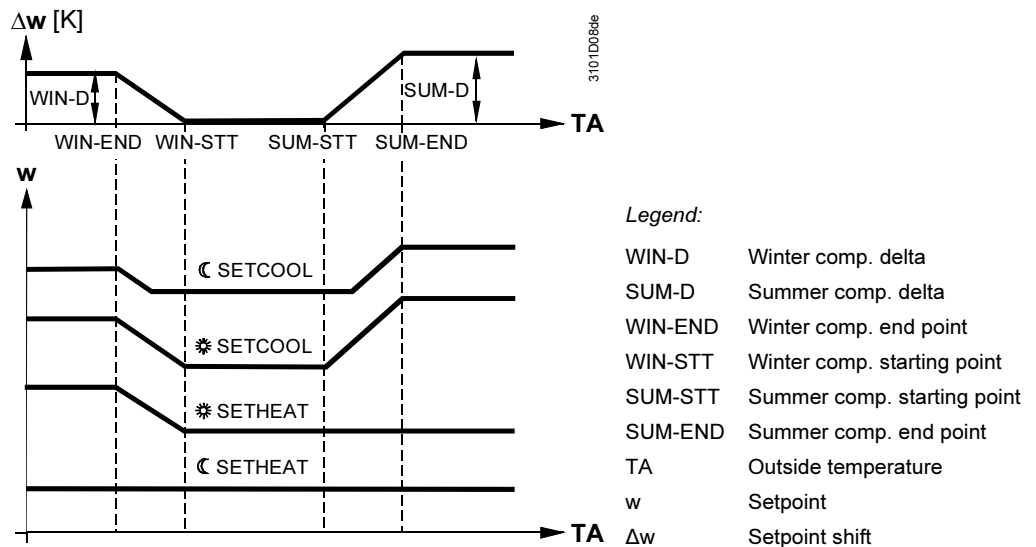

Explanations for the diagram

- Upward adjustment at low outside temperatures acts on heating and cooling
- Downward adjustment at low outside temperatures acts on heating
- Upward adjustment at high outside temperatures acts on heating and cooling
- Downward adjustment at high outside temperatures acts on heating and cooling

Application

The purpose of summer/winter compensation is as follows:

- Summer compensation to compensate for the lighter clothing worn by building occupants
- Winter compensation to compensate for cold surfaces in the room, such as the windows

8.12.3 Error handling

OT sensor signal available?

If there is no outside temperature sensor signal, the controller does not adjust the setpoint.

8.12.4 Settings

Setting values

Path: ... > PARA > CTLOOP 1

Display	Name	Range	Factory setting
SUM-D	Summer compensation delta		0 K
SUM-END	Summer compensation end		30 °C
SUM-STT	Summer compensation start		20 °C
WIN-STT	Winter compensation start		0 °C
WIN-END	Winter compensation end		-10 °C
WIN-D	Winter compensation delta		0 K

8.13 Universal setpoint shift

8.13.1 Activation

Controller 1, basic type U Controller 2

This universal setpoint compensation function is available in:

- Controller 1, basic type U only
- Controller 2

In order to activate the function, configure an appropriate output. You can only assign analog inputs.

8.13.2 Operating principle

Function

You can use a universal input to adjust the controller's setpoint.

Diagram

This setpoint compensation function acts on the "comfort" and "economy" modes according to the following diagram:

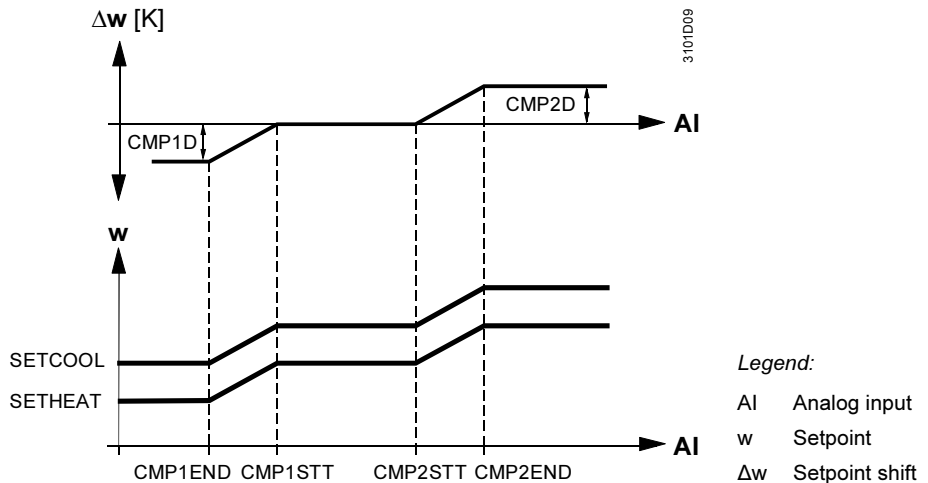

Application

Typical applications for the universal setpoint shift are:

- Refrigeration: adjustment of the supply temperature setpoint for a chilled ceiling according to room enthalpy or surface temperature
- Ventilation: adjustment according to room humidity or surface temperature

8.13.3 Error handling

Sensor connected?

When you leave the commissioning menu, the universal controller checks whether a sensor is connected to the input.

- If a sensor is connected at that time but is later missing, the controller generates a sensor alarm, and presents it on the display:
 - "Xx ---" => sensor missing
 - "Xx 000" => short circuit
- If the sensor is not connected at the time, the setpoint compensation function is disabled.

8.13.4 Settings

Configuration

Path: ... > **COMMIS** > **CONFIG** > **CTLOOP 1**

... > **COMMIS** > **CONFIG** > **CTLOOP 2**

<i>Display</i>	<i>Name</i>	<i>Range / remark</i>
SHIFT	Universal shift	Adjustable values: ---, X1, X2, ... (analog values only)

Setting values

Path: ... > **PARA** > **CTLOOP 1**

... > **PARA** > **CTLOOP 2**

<i>Display</i>	<i>Name</i>	<i>Range</i>	<i>Factory setting</i>
CMP2D	[Setp compensation 2] delta		0 K
CMP2END	[Setp compensation 2] end		30 °C
CMP2STT	[Setp compensation 2] start		20 °C
CMP1STT	[Setp compensation 1] start		0 °C
CMP1END	[Setp compensation 1] end		-10 °C
CMP1D	[Setp compensation 1] delta		0 K

8.14 Deviation message (DV ALM)

8.14.1 Activation

1 deviation signal relay per universal controller

The main controlled variable MAIN or SUPPLY of an RLU2... universal controller can generate a deviation message.

In order to activate the function, connect the DV ALM output of the controller function block to any Q... switch output of the RLU2... controller.

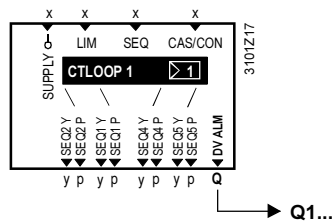

Note

The universal controllers of type RLU232 and RLU236 also only have one deviation signal relay. Both the CTLOOP 1 and CTLOOP 2 sequence controllers always act on the same relay.

8.14.2 Operating principle

Monitored values

The deviation message monitors the following values:

- Difference between present value and setpoint
- Sequence controller at limit
- Alarm delay time

Trigger

If a control loop is operating at the limit (all heating sequences fully open and all cooling sequences fully closed, or vice versa) and the set difference between the present value and setpoint is exceeded, the controller triggers an alarm after a definable period of time.

You can set individual alarm delay times for the upper and lower limits. Therefore, you can also use this function to monitor plants that only heat or only cool.

Presentation

The controller presents the deviation message as an alarm at the information level like this:

- Bell icon flashes
- Sequence controller 1 icon is visible
- Indication whether the deviation occurred in the heating or cooling sequences

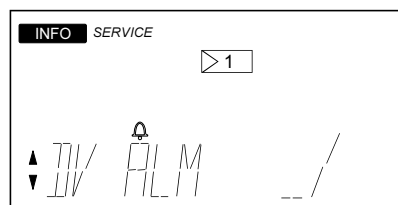

Use and configuration notes

Note the following points with regard to the deviation message:

- Set the alarm delay time long enough so that the plant does not trigger alarms on startup.
- The deviation message always refers to the sequence controller. Therefore, in the case of room/supply air temperature cascade control, it monitors the supply air. Set the values accordingly.
- The deviation message only works when the control process is enabled.

- If a sequence is limited by general or sequence limit control, it will not generate a deviation message.
- The assignment is made in the configuration diagram, always at sequence controller 1.
- If you set both the deviation message and the timeout period for the sequence controller, ensure that the alarm delay time for the deviation message is longer than the timeout period.
If you fail to do so, there will be a deviation message every time the timeout acts on the sequence controller.

8.14.3 Settings

Configuration

Path: ... > **COMMIS** > **CONF** > **CTLOOP 1**

<i>Display</i>	<i>Name</i>	<i>Range / remark</i>
DV ALM	deviation message	Activates the deviation signal function; adjustable values: ---, Q1, Q2, ... (relays only)

Setting values

Path: ... > **PARA** > **CTLOOP 1**
... > **PARA** > **CTLOOP 2**

<i>Display</i>	<i>Name</i>	<i>Range</i>	<i>Factory setting</i>
DV ALM	deviation message	Main controlled variable input signal range	100 K, 100 %, 900.0, 9000
DV DLYH	Deviation message delay high	00.00...6.00 h.m	00.30 h.m
DV DLYL	Deviation message delay low	00.00...6.00 h.m	00.30 h.m

Display values

Path: **CHK**

<i>Display</i>	<i>Name</i>	<i>Remarks</i>
DV ALM	Deviation message	Indication of present state: OFF, ON

Wiring test

Path: ... > **COMMIS** > **TEST**

<i>Display</i>	<i>Name</i>	<i>Positions</i>
DV ALM	Deviation message	OFF, ON

8.14.4 Application example

Chilled water supply temperature control

Basic type U / supply temperature control for chilled water:

With an upward adjustment of the setpoint, the water can take a very long time to warm up if the valves are closed and the pipe is well insulated.

Necessary delay time

The upper alarm delay time (DV DLYH) is set to 6 h in this case in order to avoid unnecessary alarms.

Note

If the setpoint deviation is still present after 6 hours, you can assume that the valves do not close properly.

9 Frost protection (FROST)

9.1 Purpose and types of monitoring

Purpose of FROST

The FROST (frost protection) function block protects hot-water air heaters against freezing.

Types of frost protection monitoring

This function is available only once in all devices. It provides for the following types of frost protection monitoring:

- Frost protection unit (DIG)
- 2-stage frost protection on the air side (0-10)
- 2-stage frost protection on the water side (NI)

Note

Please note that frost protection control cannot protect the plant against frost damage if there is insufficient heat output (e.g. no heating water)!

9.2 Activating the function block

Configuration

In order to activate this function, configure the identifier (LABEL) of an input as frost (FRST).

Setting

The TYPE (identification) setting defines the monitor or sensor used for frost detection. One of the following frost protection functions becomes active depending on the setting:

Setting	Frost protection function
"DIG"	Frost protection unit
"0-10"	2-stage frost protection on the air side with active signal DC 0...10 V = 0...15 °C.
"NI"	2-stage frost protection on the water side, frost protection sensor with LG-Ni 1000 passive signal

Notes

Note the following points with regard to planning and activation of the frost protection function:

- It must be possible to switch off the fans in case of frost hazard. You can configure a fan release relay (RELEASE) for this purpose. We recommend configuring function block output Q to controller output Q1 with:
 - Changeover contact Q11-Q14 closed => fan release
 - Changeover contact Q11-Q14 open => frost hazard
- For proper functioning of the 2-stage, water-side frost protection function, there must be an air heater pump. If you want to switch it on via the controller, the outside temperature signal must be available.
- Additionally, the controller assigned to the frost protection function must be the one to which the air heater at risk from frost is connected.
- If other influences act on the sequence controller at the same time, the order of priorities applies as shown in chapter 8.1.4, Function Priorities.

9.3 Settings

Configuration

Path: ... > **COMMIS** > **CONF** > **X...**

Display	Name	Range / remark
LABEL	Input identifier	Activates the function with the assignment of the value FRST (frost protection) to the input.

Setting values

Path: ... > **PARA** > **FROST**

Display	Name	Range	Factory setting
TYPE	Identification	Monitor (DIG), air side (0-10), water side (NI)	DIG

9.4 Operating principle

9.4.1 Frost protection unit (DIG)

Application example

This picture shows an application with an air or water-side frost protection unit:

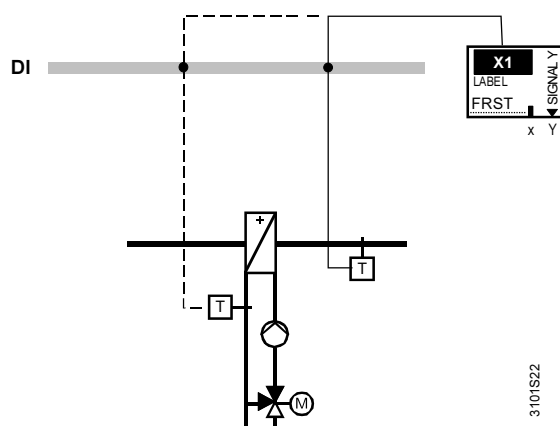

Note

Reliable frost protection depends on correct sensor placement.

Frost protection control functions

If the temperature falls below the set limit value, the frost protection unit transmits a signal to the controller. Meanings:

- Monitor contact (Q11-Q14 / terminals 1-3) closed: no frost hazard
- Monitor contact (Q11-Q14 / terminals 1-3) open: Frost hazard

A frost hazard signal triggers the following actions:

- The fan release relay is de-energized (fan not enabled).
- The control loop configured with the air heater at risk from frost switches off all cooling sequences, and opens all heating sequences to 100 %. It also switches the air heater pump on.
=> important: step switches also switch on in the process!
- If two controllers are configured in the RLU2..., the second (other) control loop switches off.
- The heat recovery unit switches off, and the outdoor air damper closes.

Note

The frost protection function with frost protection unit is activated in all operating modes (comfort, economy, protection). Therefore, it also overrides limit controls and interlocks based on the outside temperature!

9.4.2 2-stage frost protection on the air side (0-10)

Application example

This picture shows an application with 2-stage, air-side frost protection:

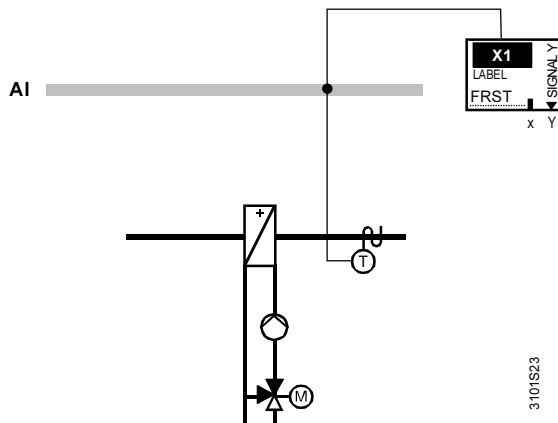

Note

Reliable frost protection depends on correct sensor placement.

Temperature goes below starting point

The temperature going below the starting point (= limit value + 2 K + P-band) produces the following reactions:

- The controller steplessly opens all heating sequences and steplessly closes all cooling sequences.
- The air heater pump switches on.

The purpose is to prevent the temperature from falling below the "frost hazard" limit value (SET-ON).

Reactions if temperature goes below limit value

If the temperature still goes below the above limit value, the following reactions take place:

- The fan release relay is de-energized (fan not enabled).
- The control loop configured with the air heater at risk from frost switches off all cooling sequences, and opens all heating sequences to 100 %. It also switches the air heater pump on.
=> important: step switches also operate!
- If two controllers are configured in the RLU2..., the second (other) control loop is switched off.
- The heat recovery unit switches off, and the outdoor air damper closes.

Function diagram

This diagram illustrates the above statements:

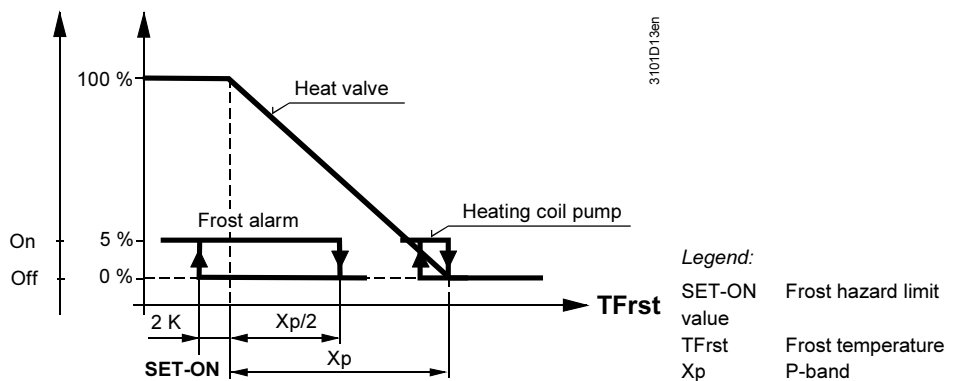

Note

The frost protection function remains active when the plant is off.

9.4.3 2-stage frost protection on the water side (NI)

Application example

This picture shows an application with 2-stage, water-side frost protection:

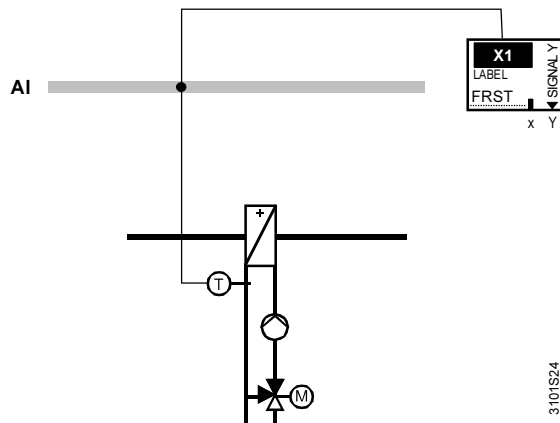

Project engineering notes

Observe the following points with regard to sensor placement and the heating circuit pump:

- Reliable frost protection depends on correct sensor placement.
Position the sensor in or on the water-side outlet of the air heater within the air duct.
- As an additional protection function, the heating circuit pump must switch on automatically at outside temperatures below 5 °C (setting value "switch-on according to outside temperature", see chapter 7.1 Pump (PUMP x)).

Temperature goes below starting point

If the temperature going below the starting point (= limit value + 2 K + P-band) the controller steplessly opens all heating sequences and steplessly closes all cooling sequences. The purpose is to prevent the temperature from falling below the "risk of frost limit" (SET-ON).

Reactions if temperature goes below limit value

If the temperature still goes below the above limit value, the following reactions take place:

- The fan release relay is de-energized (fan not enabled).
- The control loop configured with the air heater at risk from frost switches off all cooling sequences, and opens all heating sequences to 100 %. It also switches the air heater pump on.
=> important: step switches are also switched on in the process!
- If two controllers are configured in the RLU2..., the second (other) control loop is switched off.
- The heat recovery unit switches off, and the outdoor air damper closes.

Function diagram

This diagram illustrates the above statements:

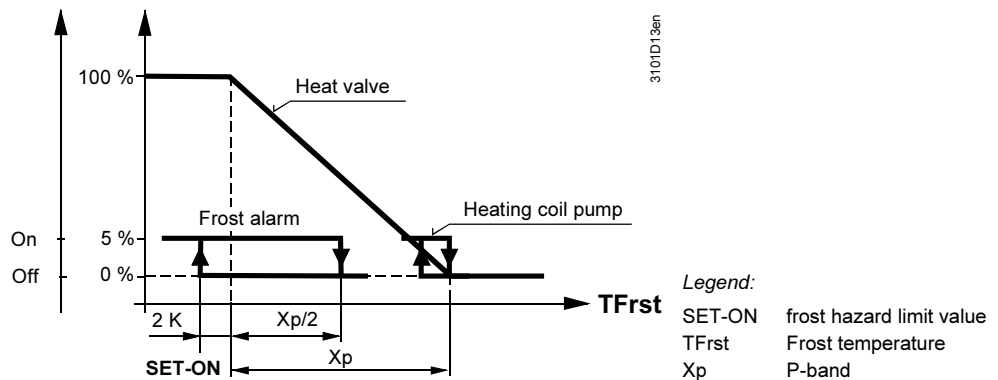

Behavior if the plant is switched off

If the plant is switched off, the controller controls the air heater temperature to a definable plant OFF frost protection setp (SET-OFF) value with PI control action (OFF XP, OFF TN) so that the air heater already has stored heat on startup. This function acts on all heating sequences of the configured control loop (including step switches, but:

The heat recovery unit remains off, and the outdoor air damper remains closes (see chapter 7.3 Heat Recovery Equipment / Mixed Air Damper [HREC]).

9.5 Acknowledgement / reset (AKN)

Release conditions

The frost protection relay does not enable the fan again until there is no longer a frost alarm and the signal has been reset.

You can choose between the following alarm reset alternatives:

- Acknowledgement autom 3x (YES3): Only the third frost alarm occurring within an hour needs to be acknowledged and reset.
- Acknowledgement manual (YES): All frost alarms have to be acknowledged and reset.

Note

If the frost protection unit has an alarm latch of its own, you have to reset the frost alarm at the monitor. The plant will not restart until you have reset the frost alarm at the frost protection unit and acknowledged it at the controller.

Procedure for a pending frost alarm

Apply the following procedure in case of a pending frost alarm:

1. Press the **ESC** button once => acknowledges the alarm
2. Press the **ESC** button again => resets the alarm

See also chapter 10.2.2 Alarm Acknowledgement.

9.6 Display indication

Pending frost alarm

The controller displays a pending frost alarm like this:

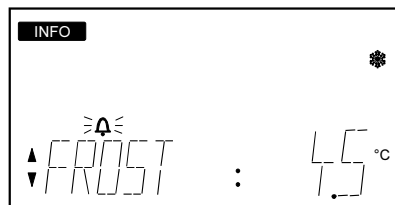

9.7 Connection diagrams

Connection diagram, monitor

You can connect a frost protection unit to the input. The monitor must be connected according to the following diagram:

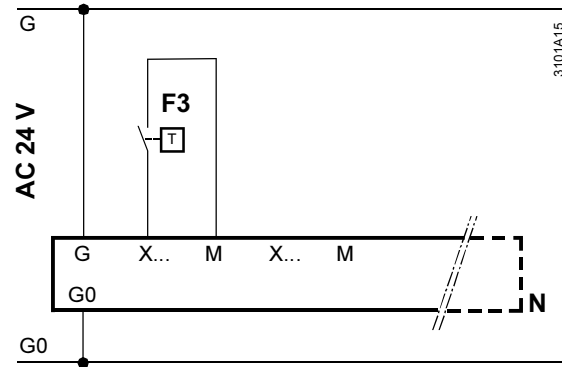

Connection diagram, water

You can connect a passive LG-Ni 1000 temperature sensor to the input. The sensor must be connected according to the following diagram:

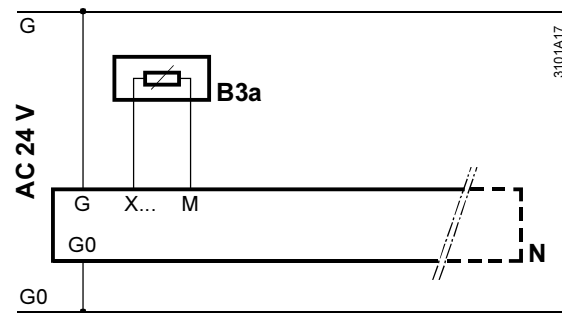

Connection diagram, air

You can connect an active temperature sensor with a DC 0...10 V = 0...15 °C signal to the input: The sensor must be connected according to the following diagram:

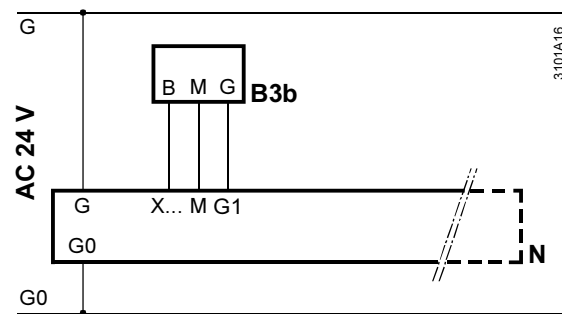

Legend for the connection diagrams

F3	QAF81 frost protection unit (air)
B3a	QAE26.9 immersion temperature sensor (water)
B3b	QAF63... frost sensor (air)
N	RLU2... universal controller

9.8 Error handling

Frost protection unit

Digital signals cannot be monitored.

A missing signal (= contact open) is interpreted as a frost alarm, which activates frost protection control.

2-stage frost protection on the air side

A missing signal from the frost sensor is interpreted as a frost alarm, which activates frost protection control.

2-stage frost protection on the water side

A missing signal from the frost sensor is interpreted as a frost alarm, which activates frost protection control.

If there is no outside temperature sensor signal, the pump is permanently on. The "switch-on according to outside temperature" setting value must be set to 5 °C; see chapter 7.1, Pump (PUMP x).

Response with multiple inputs

If more than one input is configured as a frost protection input, the controller accepts the first configured input as the frost protection input.

9.9 Settings

Configuration

Path: ... > **COMMIS** > **CONF** > **X..**

<i>Display</i>	<i>Name</i>	<i>Range / remark</i>
LABEL	Input identifier	Activates the function with the assignment of the value FRST (frost protection) to the input.

Setting values

Path: ... > **PARA** > **FROST**

<i>Display</i>	<i>Name</i>	<i>Range</i>	<i>Factory setting</i>
SET-ON	Risk of frost limit	-50...+50 °C	5 °C
XP	P-band Xp	0.5...999.5 K	5 K
SET-OFF	Plant OFF frost protection setp	-50...+50 °C	20 °C
OFF XP	Plant OFF Xp	0.5...999.5 K	7 K
OFF TN	Plant OFF Tn	00.00...60.00 mm.ss	mm.ss
ACK	Fault acknowledgement	YES (acknowledgement manual) YES3 (acknowledgement autom 3x)	YES
TYPE	Identification	DIG (digital), 0-10 (active DC 0...10 V = 0...15 °C), NI (passive Ni1000)	DIG
ACTING	Control loop with risk of frost	1...2	1

Display values

Path: **CHK**

<i>Display</i>	<i>Name</i>	<i>Remarks</i>
FROST	Actual value frost protection	

Wiring test

Path: ... > **COMMIS** > **TEST**





<i>Display</i>	<i>Name</i>	<i>Positions</i>
FROST	Actual value frost protection	

10 Dealing with alarms

10.1 Alarm list

Causes

The following list includes all possible causes of alarm with their priorities and how they are presented on the display:

<i>Display</i>	<i>Error/alarm cause</i>	<i>Priority</i>	<i>Effect</i>
FROST	Frost hazard Type: Extended Alarm	1	See pages 95...99
MAINALM 	Main controlled variable missing Sequence controller 1 Type: Simple Alarm	2	See pages 22, 65, 70, 73, 77
MAINALM 	Main controlled variable missing Sequence controller 2 Type: Simple Alarm	3	See pages 22, 65, 70, 73, 77
DV ALM 	Deviation alarm, sequence controller 1 _ : deviation low _ / : deviation high Type: Simple Alarm	4	See pages 93...94
DV ALM 	Deviation alarm, sequence controller 2 _ : deviation low _ / : deviation high Type: Simple Alarm	5	See pages 93...94
X1 --- / ooo	Sensor fault X1 Type: Simple Alarm	6	See pages 27...34
X2 --- / ooo	Sensor fault X2 Type: Simple Alarm	7	See pages 27...34
X3 --- / ooo	Sensor fault X3 Type: Simple Alarm	8	See pages 27...34
X4 --- / ooo	Sensor fault X4 Type: Simple Alarm	9	See pages 27...34
X5 --- / ooo	Sensor fault X5 Type: Simple Alarm	10	See pages 27...34
STATUS OK	Indication in normal mode	11	

Legend

<i>Symbol</i>	<i>Meaning</i>
---	Open circuit
ooo	Short circuit

10.2 Troubleshooting

10.2.1 Alarm indication

Indications and corrective action

The controller presents alarms from the plant with the  icon in the display.

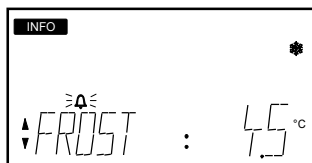

If  is flashing:

1. Press the **ESC** button to acknowledge the alarm.

If  is displaying but not flashing:

1. Rectify the cause of the alarm.
2. When you have rectified the cause, press the **ESC** button again to reset the alarm.

If the plant is functioning normally again, "STATUS: OK" will appear on the information display:

10.2.2 Alarm acknowledgement

No acknowledgement needed (Simple Alarm)

This applies to all alarms that you do not have to acknowledge or reset.

Example:

If there is a deviation message, the controller signals an alarm. When the main controlled variable returns to the optimal range, the alarm disappears automatically, and the plant continues to operate normally.

Acknowledge (BASIC Alarm)

This applies to all alarms that you only have to acknowledge. An external solution is required for alarm latching and resetting.

Important:

When the alarm disappears (via external reset) the plant returns to normal operation – whether you have acknowledged the alarm or not.

Example:

A frost protection unit that requires local resetting is installed in the plant. The only purpose of the alarm indication is to make sure that the service staff take note of the alarm.

Acknowledge and reset (Extended Alarm)

This applies to all alarms that you have to acknowledge and reset.

The alarm remains after you have acknowledged it, until the fault signal is no longer present. Only then can you reset the alarm. The alarm icon disappears when you reset the alarm.

Example:

A frost protection sensor is installed in the plant. In case of an alarm, you have to acknowledge and reset it via the operator interface. The plant does not restart until then.

11 Electrical connections

11.1 Connection rules

Terminal connection concept

The following picture shows the terminal base of the RLU236 controller with its connections:

- Extra-low-voltage side at the top
- Mains voltage side at the bottom

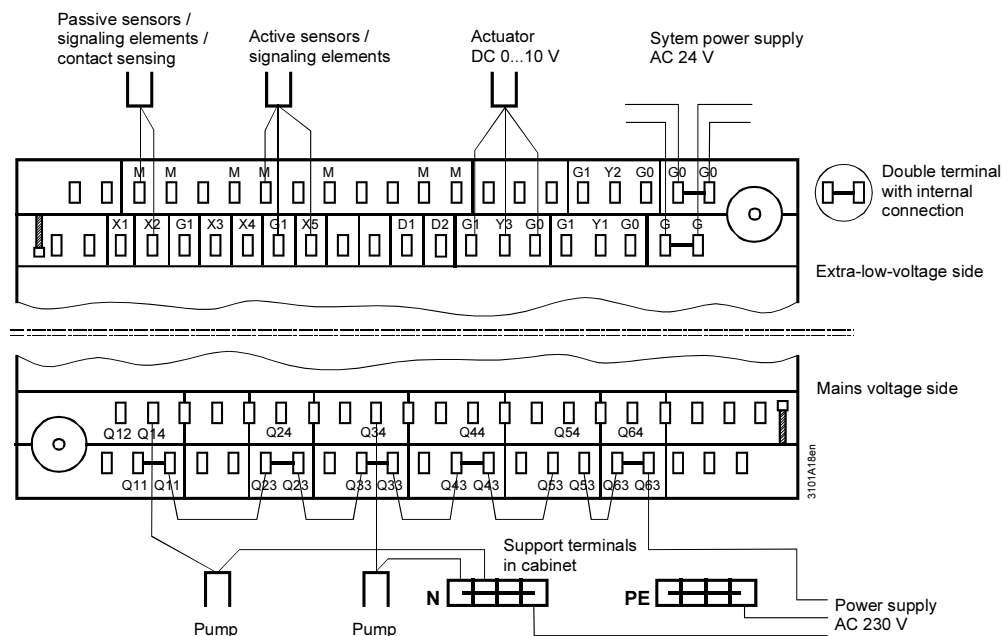

Terminal assignment

Terminals	Intended for ...
Xx, M	Passive sensors and signaling elements, voltage-free contacts (contact sensing)
G1, Xx, M	Active sensors and signaling elements
G1, Yx, M	Actuators
G and G0	AC 24 V system power supply

Note

Connect only one solid or stranded wire per terminal.

Connection procedure with spring cage terminals

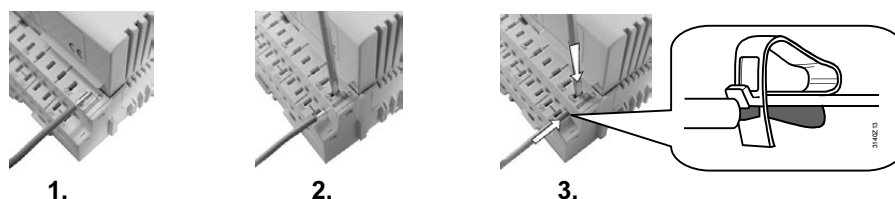

Steps

1. Strip the wire over a length of 7...8 mm
2. Position the wire and screwdriver (size 0 to 1)
3. Apply pressure with the screwdriver while inserting the wire
4. Remove the screwdriver

11.2 Connection terminals

11.2.1 Universal controller RLU2...

RLU210

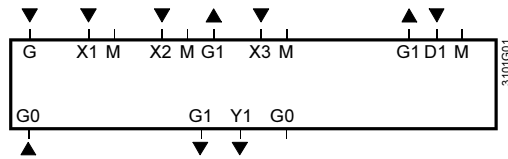

RLU222

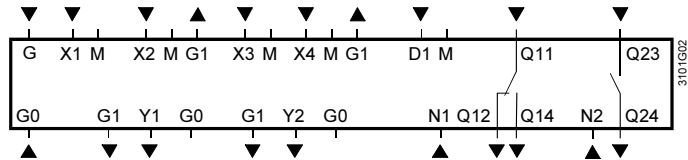

RLU232

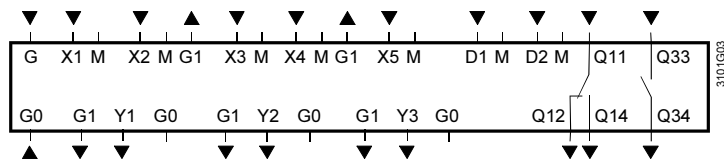

RLU236

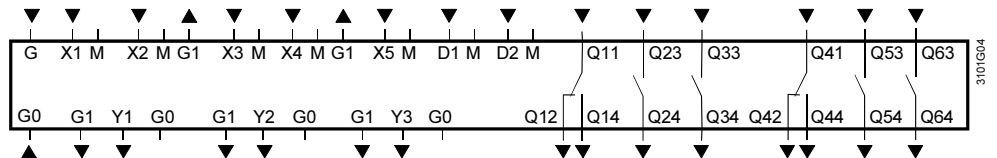

Legend

G, G0	AC 24 V rated voltage
G1	AC 24 V power supply for active sensors, signal sources or limiters
M	Measuring neutral for signal input
G0	System neutral for signal output
X1...X6	Universal signal inputs for LG-Ni 1000, 2x LG-Ni 1000 (averaging), T1, Pt 1000, DC 0...10 V, 0...1000 Ω (setpoint), 1000...1175 Ω (rel. setpoint), voltage-free contacts (contact sensing)
D1...D2	Digital signal inputs for voltage-free contacts (contact sensing)
Y1...3	Control and status signal outputs, analog DC 0...10 V
Q...	Voltage-free relay outputs (N.O. / changeover) for AC 24...230 V

12 Appendix

12.1 Abbreviations used

To facilitate reading, the most common abbreviations are listed below in alphabetical order.

<i>Abbreviation</i>	<i>Meaning</i>
⊕	Heating
⊖	Cooling
Δw	Setpoint shift
AB	Extract air
AC	Alternating current
AI	Analog Input
AO	Analog Output
OA	Outside air
CMP	Setpoint compensation
DC	Direct current
DI	Digital input
DO	Digital output
DX	Direct expansion cooling
EHA	Exhaust air
I	I-response
LCD	liquid crystal display
AHC	Air heating coil
ACC	Air cooling coil
MECH	Maximum economy changeover (MECH)
P	P-response
PI	PI-response
Q	Load output
SA	Switching interval
SD	Switching differential
SpTSu	Supply air temperature setpoint
SpTSuH	Supply air temperature setpoint heating
SpTSuC	Supply air temperature setpoint cooling
t	Time
TA, TOa	Outside temperature
TE _x	Exhaust air temperature
T _{Frst}	Frost temperature
T _n	Integral-action time
TR	Room or exhaust air temperature
TRL	Return temperature
TSu	Supply air temperature
TW	Water temperature
w	Setpoint
x	Present value
X _{dz}	Dead zone
X _p	P-band
Y, Y _{ctl}	Controller output
ZU	Supply air

12.2 Synco 200 operating texts

<i>Operating text</i>	<i>Explanation</i>
°C	Degrees Celsius
F	Degrees Fahrenheit
0.0	Universal 000.0
0000	Universal 0000
0-10	Active DC 0...10 V = 0...15 °C
2xNI	2xNi1000
3P	3-position
3-POINT	3-position output
A	Basic type A room temp
ACCESS	Access levels
ACK	Fault acknowledgement
ACTING	Control loop with risk of frost
ACTTIME	Actuator run time
ADAP	Plant type adapted
AO	Modulating output
APPL ID	Plant type
AUTO	Auto
CAS/CON	Casc/const changeover input
CASC	Cascade
CH OVER	2-pipe heating/cooling system
CLOS	Closing
CLSD	Closed
CMF	Comfort
CMP1D	[Setp compensation 1] delta
CMP1END	[Setp compensation 1] end
CMP1STT	[Setp compensation 1] start
CMP2D	[Setp compensation 2] delta
CMP2END	[Setp compensation 2] end
CMP2STT	[Setp compensation 2] start
CNST	Constant
COMB	Alternating
COMMIS	Commissioning
CONFIG	Extra configuration
COOL	Cooling
COOLER	Air cooling coil valve
CORR	Correction
CTL1	Controller 1
CTL2	Controller 2
CTLOOP 1	Controller 1
CTLOOP 2	Controller 2
DIFF	Differential input
DIG	Frost protection unit Digital
DIG	Digital
DLY OFF	Switch-off delay
DV ALM	Deviation signal
DMP	Mixed air damper
DV DLYH	Deviation signal delay top
DV DLYL	Deviation signal delay bottom
ECO	Economy
ERC	Heat recovery equipment
EXP	Password
FROST	Actual value frost protection
FRST	Frost protection
HEAT	Heating
HREC	Heat recovery output
HREC	Mixing dampers/HR
IN X	Preselection external

Synco 200 operating texts, *continued*

INVALID	Caution!
INVERS	Inversion
LABEL	Input identifier
LIM	General limit controller
LIM DHI	Gen limiter differential high
LIM DLO	Gen limiter differential low
LIM MAX	Gen limiter limit value high
LIM MIN	Gen limiter limit value low
LIM TN	Gen limiter integr action time Tn
LIM X	Actual value general limiter
LIM XP	Gen limiter P-band Xp
LIMCOOL	Reduction min limitation cooling
LOCK S1	[Sequence 1] outside temp >
LOCK S2	[Sequence 2] outside temp >
LOCK S4	[Sequence 4] outside temp <
LOCK S5	[Sequence 5] outside temp <
MAIN	Main controlled variable
MAINALM	Main contr var sensor error
MAX	Limitation max
MAX	Maximum
MAX POS	Positioning signal max
MAX VAL	Value high
MECH 1	MECH input 1
MECH 2	MECH input 2
MECHSET	MECH limit value
MIN	Limitation min
MIN	Minimum
MIN POS	Positioning signal min
MIN VAL	Value low
MODE	Operating mode
NI	Passive Ni1000
NO	No
NO	None
NORMPOS	Normal position
OFF	Off
OFF TN	Plant OFF Tn
OFF XP	P-band Xp
OFFTIME	Locking time
OFF-Y	Load-dependent OFF
OHM	Ohm
OK	OK
ON	On
ON DLY	Startup delay
ON-OUTS	Outside temp-dependent ON
ON-Y	Load-dependent ON
OPEN	Opening
OPEN	Open
OPMODE	Preselected optg mode input
ORIG	Plant type original (not adapted)
OUTS	Outside temperature
OUTSIDE	Actual value outside temp
PASSWRD	Password
PCF	Precomfort
PRIO CH	Run priority changeover
PRT	Protection
PT	Pt1000
PU1	Pump 1
PU2	Pump 2
PU3	Pump 3

Synco 200 operating texts, *continued*

PUMP 1	Pump 1
PUMP 2	Pump 2
PUMP 3	Pump 3
REL	Rem setp adjuster relative
RELEASE	Fan release relay
REM1	[Controller 1] rem setp adj
REM2	[Controller 2] rem setp adj
ROOM	Room temperature
ROOM	Actual value room temp
ROOM TN	Room influence Tn
ROOM XP	Room influence Xp
S V1	Variable step switch 1
S V2	Variable step switch 2
S1-OFF	[Step 1] OFF
S1-ON	[Step 1] ON
S2-OFF	[Step 2] OFF
S2-ON	[Step 2] ON
S3-OFF	[Step 3] OFF
S3-ON	[Step 3] ON
S4-OFF	[Step 4] OFF
S4-ON	[Step 4] ON
S5-OFF	[Step 5] OFF
S5-ON	[Step 5] ON
S6-OFF	[Step 6] OFF
S6-ON	[Step 6] ON
SBIN	Binary step switch
SEQ	Sequence limit controller
SEQ MOD	Type of limitation
SEQ SEL	Sequence selection
SEQ SET	Seq limiter limit value
SEQ XP	Seq limiter P-band Xp
SEQ TN	Integral action time Tn
SEQ1	Sequence 1
SEQ1 LD	[Sequence 1 _] load
SEQ1 P	[Sequence 1] pump
SEQ1 TN	[Sequence 1 _] Tn
SEQ1 TV	[Sequence 1 _] Tv
SEQ1 XP	[Sequence 1 _] Xp
SEQ1 Y	[Sequence 1] load
SEQ2	Sequence 2
SEQ2 LD	[Sequence 2 \.._] load
SEQ2 P	[Sequence 2] pump
SEQ2 TN	[Sequence 2 \.._] Tn
SEQ2 TV	[Sequence 2 \.._] Tv
SEQ2 XP	[Sequence 2 \.._] Xp
SEQ2 Y	[Sequence 2] load
SEQ4	Sequence 4
SEQ4 LD	[Sequence 4 _/] load
SEQ4 P	[Sequence 4] pump
SEQ4 TN	[Sequence 4 _/] Tn
SEQ4 TV	[Sequence 4 _/] Tv
SEQ4 XP	[Sequence 4 _/] Xp
SEQ4 Y	[Sequence 4] load
SEQ5	Sequence 5
SEQ5 LD	[Sequence 5 _.. /] load
SEQ5 P	[Sequence 5] pump
SEQ5 TN	[Sequence 5 _.. /] Tn
SEQ5 TV	[Sequence 5 _.. /] Tv
SEQ5 XP	[Sequence 5 _.. /] Xp

Synco 200 operating texts, *continued*

SEQ5 Y	[Sequence 5] load
SERV	Service level
SET MAX ☀	Comfort setpoint high
SET MAX ☾	Economy setpoint high
SET MIN ☀	Comfort setpoint low
SET MIN ☾	Economy setpoint low
SETCOOL ☀	Comfort cooling setpoint
SETCOOL ☾	Economy cooling setpoint
SETHEAT ☀	Comfort heating setpoint
SETHEAT ☾	Economy heating setpoint
SET-OFF	Plant OFF frost protection setp
SET-ON	Risk of frost limit
SETPOINT	Setpoints
SETTING	Settings
SHIFT	Universal shift
SIGNALY	Measured value signal output
SLIN	Linear step switch
START OK	Caution! Plant starts
STATUS	Device state
STEP 1	Step 1
STEP 2	Step 2
STEP 3	Step 3
STEP 4	Step 4
STEP 5	Step 5
STEP 6	Step 6
STEP V1	Variable step switch 1
STEP V2	Variable step switch 2
STEPBIN	Binary step switch
STEPLIN	Linear step switch
STOP OK	Caution! Plant stops
SU DMAX	Max limitation supply air delta
SU DMIN	Min limitation supply air delta
SU MAX	Supply air limit value max
SU MIN	Supply air limit value min
SUM-D	Summer compensation delta
SUM-END	Summer compensation end
SUM-STT	Summer compensation start
SUPPLY	Supply air temperature
SW-VERS	Software version
TIMEOUT	Control timeout
TOOLING	Operation locked
TYPE	Type
TYPE	Identification
U	Basic type U univ controller
UNIT	Unit
USER	User level
VALUES	Inputs / outputs
WIN-D	Winter compensation delta
WIN-END	Winter compensation end
WIN-STT	Winter compensation start
WIRING TEST	Wiring test
XP	P-band Xp
YES	Yes
YES	Acknowledgement manual
YES3	Acknowledgement autom 3x

12.3 Configuration

12.3.1 Explanation of the configuration principle

Configuration diagrams, contents	<p>The controller includes a large number of pre-configured function blocks. The function blocks available for the various RLU2... universal controllers are shown the respective configuration diagrams. They include:</p> <ul style="list-style-type: none">• Input identifiers (inputs, input functions)• Function blocks for open and closed-loop control functions• Aggregates (outputs, output functions)
Configuration diagrams, use	<p>Project engineers can add connections from the individual input and output functions (i.e. their internal signals) to the assigned terminals.</p>
Identifiers used	<p>Physical inputs:</p> <ul style="list-style-type: none">• D digital• X universal <p>Physical outputs:</p> <ul style="list-style-type: none">• Q relay• Y DC 0...10 V
Use of Xx inputs	<p>Be careful to observe the following rules and properties when using the inputs:</p> <ul style="list-style-type: none">• The input identifier can be a device or a special sensor: OUTS (outside temperature), ROOM (room temperature), FRST (frost protection), REMx (setpoint adjuster)• Multiple use of input signals is possible without limitation (e.g. room temperature signal as the main controlled variable and as the maximum economy changeover criterion for the damper)• When an input is connected, the controller presents only the possible unit on the display.• Input alarming is only enabled if the input is connected before completion of commissioning.• If you change an input identifier (LABEL) all of the settings associated with it also change (e.g. Xp used to be 28 K, and now it is 10 Pa).
Configuration procedures	<p>Sequence:</p> <ul style="list-style-type: none">• First the basic configuration (APPL ID), then the extra configuration (CONFIG)• First the input identifiers (LABEL), then the control functions, and then the aggregates. <p>Wiring choices:</p> <ul style="list-style-type: none">• Always from the arrow to the line• From the function to the input: "x" to "x"• From the output block to the output terminal: Analog "Y" to "Y"• Relay "Q" to "Q"• From the controller: load "y" to "y", pumps "p" to "p"
Use of Yx outputs	<p>Be careful to observe the following when using the outputs:</p> <ul style="list-style-type: none">• Connect the output functions to the correct terminals. Each output terminal can only be used once (e.g. Q1 for Pump 1)• Each output function has no more than 2 load signal inputs with maximum selection. Example: The air cooler valve opens if the room temperature or room air humidity is too high.

12.3.2 Function block overview

Introduction





The following pages provide an overview of the function blocks for the RLU2... universal controllers, including a brief description.

The configuration diagrams for the specific device type indicate how many of each function block are available.

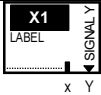

Basic configuration

Configuration	Function
APPL ID (plant type)	<ul style="list-style-type: none"> • Basic type A: room temperature ventilation controller (sequence controller 1 is a room temperature controller, room/supply air temperature cascade controller or supply air temperature controller) • Basic type U: universal controller (sequence controller 1 is a universal controller) • A01 ... , U01 ...: programmed application selection (activates a stored configuration in the controller)

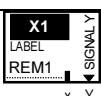
Input identifier

LABEL (inputs)	Configuration	Functions
	X1...X5 SIGNAL Y	<p>Enter the input identifier (LABEL)</p> <ul style="list-style-type: none"> • Physical units: °C (TEMP), %, Universal 0.0 (display with one decimal place), Universal 0000 (display with no decimal places). The unit is only required for presentation on the display. The controller presents all settings that depend on the unit (e.g. P-bands) in the unit. Sensors for °C: Ni 1000, 2x LG-Ni 1000 (averaging), T1, Pt 1000, DC 0...10 V, all other units DC 0...10 V, adjustable range • Digital (input for voltage-free contacts) • Special identifiers: Room temperature (ROOM), outside temperature (OUTS), frost protection (FRST), remote setpoint adjuster, absolute (REM) or relative (REL). The controller itself makes internal connections for the special identifiers. • SIGNAL Y provides for signalization of the passive sensor value as a DC 0...10 V signal via the Yx terminal of your choice.
	Room temperature	Sensor as described under "Sensors for °C"
	Outside temperature	<p>Sensor as described under "Sensors for °C" for the following functions:</p> <ul style="list-style-type: none"> • Summer/winter compensation • Sequence disabling according to outside temperature • Pump ON at low outside temperatures • Maximum economy changeover of dampers
	Frost protection	<p>Frost protection function optionally for sequence controller 1 or 2:</p> <ul style="list-style-type: none"> • 2-stage water-side frost protection (LG-Ni 1000 input); PI control when plant is OFF • 2-stage air-side frost protection (DC 0...10 V = 0...15 °C input) • Frost protection unit
	[Controller 1] rem setp adj [Controller 2] rem setp adj Rem setp adjuster relative	<ul style="list-style-type: none"> • REM 1: absolute for sequence controller 1 to 2 (0...1000 Ω or DC 0...10 V) • REL: relative for room temperature in basic type A, sequence controller 1 (1000...1175 Ω = -3...+3 K)

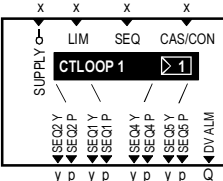
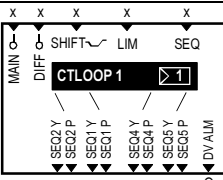
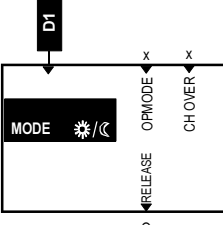
Open and closed-loop control functions

CTLOOP x (controller)	Configuration	Functions
	<p>Controller 1, basic type A</p> <ul style="list-style-type: none"> Supply air temp. (SUPPLY) Gen limit controller (LIM) Seq limit controller (SEQ) Casc./const-changeover input (CAS/CON) Sequence S1...S5 load (y) Sequence S1...S5 pump (p) Deviation message output (DV ALM) 	<p>Sequence controller, usable as a P, PI or PID controller.</p> <p>If supply air temp. (casc.) configured, usable as:</p> <ul style="list-style-type: none"> Room/supply air cascade ctrlr with supply air high/low limit control Supply air temperature controller Room temperature controller (supply air configured but not connected) <p>If supply air temp. (casc.) not configured, usable as:</p> <ul style="list-style-type: none"> Room temperature present value controller <p>Controller features:</p> <ul style="list-style-type: none"> Configurable sequence assignments; a load output (modulating output AO1...3, heat recovery unit, mixing damper, var. step switch 1...2), linear step switch, binary step switch and a pump can be connected to each sequence. Heating sequences S1 and S2 (_) Cooling sequences S4 and S5, (_//) Gen limit controller acts on all sequences Seq limit controller, definable as low or high limit controller, acts on one selectable sequence (in close direction) Summer/winter compensation with outside temperature Sequence lock acc to OT Alarm for unacceptable control deviation can be activated
	<p>Controller 1, basic type U; Controller 2, (basic types A and U):</p> <ul style="list-style-type: none"> Main controlled variable Differential input (DIFF) Universal shift SHIFT (~) Gen limit controller (LIM) Seq limit controller (SEQ) Sequence S1...S5 load (y) Sequence S1...S5 pump (p) Deviation alarm output (DV ALM) 	<p>Universally usable sequence controller, as a P, PI or PID controller.</p> <ul style="list-style-type: none"> Configurable sequence assignments; a load output (modulating output, var. step switch 1...5), linear step switch, binary step switch and a pump can be connected to each sequence. Heating sequences S1 and S2 (_) Cooling sequences S4 and S5 (_//) Simple controller or differential controller (setpoint linkable to sequence controller 1) Gen limit controller acts on all sequences Seq limit controller, definable as low or high limit controller, acts on one selectable sequence (in close direction) Universal shift Sequence lock acc to OT Alarm for unacceptable control deviation can be activated
MODE (Operating mode)	Configuration	Functions
	<p>Basic types A and U:</p> <ul style="list-style-type: none"> Operating mode input (OPMODE) Heating/cooling changeover input (CH OVER) Fan enable relay output (RELEASE) 	<p>Room operating modes.</p> <ul style="list-style-type: none"> Operating mode input (OPMODE) for changeover between comfort and economy setpoints (RLU210 and RLU222 only) Heating/cooling changeover input (CH OVER) for "2-pipe heating/cooling system (only RLU210 basic type and all basic type U controllers) Fan enable relay output (RELEASE): output for disabling the fan in case of frost and external alarms.
FROST (frost protection)	Configuration	Functions
		<ul style="list-style-type: none"> 2-stage air-side frost protection (DC 0...10 V = 0...15 °C input) Frost protection unit

Aggregates

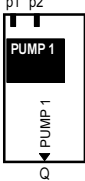
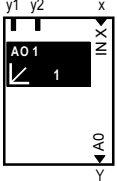
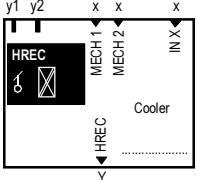
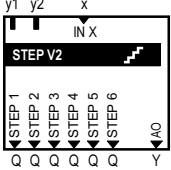
PUMP x (pump)	Configuration	Functions
	<ul style="list-style-type: none"> Output (PUMP x) 	<ul style="list-style-type: none"> Usable as an auxiliary pump (e.g. air heater pump) or as a main pump (e.g. chilled water primary controller) ON via sequence controller's load signal (from up to 2 sequences with maximum selection, adjustable switching points), OT-dependent ON (adjustable) Switch-off delay adjustable
AO x (modulating outputs)	Configuration	Functions
	<ul style="list-style-type: none"> Modulating output (AO) 	<p>For modulating DC 0..10 V signals, e.g. for fan control.</p> <ul style="list-style-type: none"> Load signal from sequence controller (from up to 2 sequences with maximum selection) "Positioning signal min" and "Positioning signal max" adjustable Inversion adjustable
HREC (HR equipment / mixed air damper)	Configuration	Functions
	<ul style="list-style-type: none"> Output (HREC) MECH input 1 (MECH 1) MECH input 2 (MECH 2) Air cooler valve (COOLER) External signal (IN X) 	<p>For controlling a heat recovery unit or mixing damper.</p> <ul style="list-style-type: none"> Configuration always with "heating" load signal from sequence controller (from up to 2 sequences with maximum selection) Maximum economy changeover, optionally with 1 input (digital or analog) or 2 inputs (differential measurement) HR equipment helps to provide cooling when the air cooler valve open (also in dehumidification case) "Positioning signal min" and "Positioning signal max" adjustable Inversion adjustable External load signal can be applied
STEP Vx (variable step switch)	Configuration	Functions
	<ul style="list-style-type: none"> Step 1 to ... (STEP x) Modulating output (AO) External signal (IN X) 	<p>For controlling a stepped aggregate.</p> <ul style="list-style-type: none"> A switch-on point and a switch-off point can be assigned to each step according to the load signal from the sequence controller (from up to 2 sequences with maximum selection) The switching points can overlap, and can be inverted (ON < OFF). External load signal can be applied Modulating output (AO x) configurable. Same function as AO x modulating outputs Locking time (restoration delay) adjustable (time applies to all steps)

Aggregates, continued

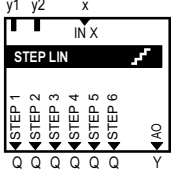
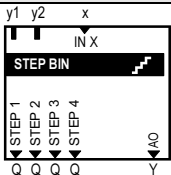
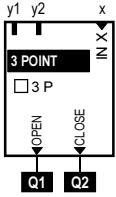
STEP LIN (linear step switch)	Configuration	Functions
	<ul style="list-style-type: none"> • Step 1 to ... (STEP x) • Modulating output (AO) • External signal (IN X) 	<p>For controlling a stepped aggregate.</p> <ul style="list-style-type: none"> • Linear distribution of the steps over the load signal range according to the number of outputs defined. • External load signal can be applied • Modulating output (AO x) configurable. Same function as AO x modulating outputs • Locking time (restoration delay) and startup delay time adjustable (time applies to all steps) • Weekly priority changeover of the steps
	<ul style="list-style-type: none"> • Step 1 to ... (STEP x) • Modulating output (AO) • External signal (IN X) 	<p>For controlling a stepped aggregate.</p> <ul style="list-style-type: none"> • Binary distribution of the steps over the load signal range according to the number of outputs defined. • External load signal can be applied • Modulating output (AO x) configurable. Same function as AO x modulating outputs • Locking time (restoration delay) adjustable (time applies to all steps)
	<ul style="list-style-type: none"> • 3-position output (3-POINT) • External signal (IN X) 	<p>For controlling an actuator with three-position action.</p> <ul style="list-style-type: none"> • End stop synchronization • External load signal can be applied • Opening and closing times adjustable for actuator

12.3.3 RLU210 configuration diagrams

RLU210, basic type A

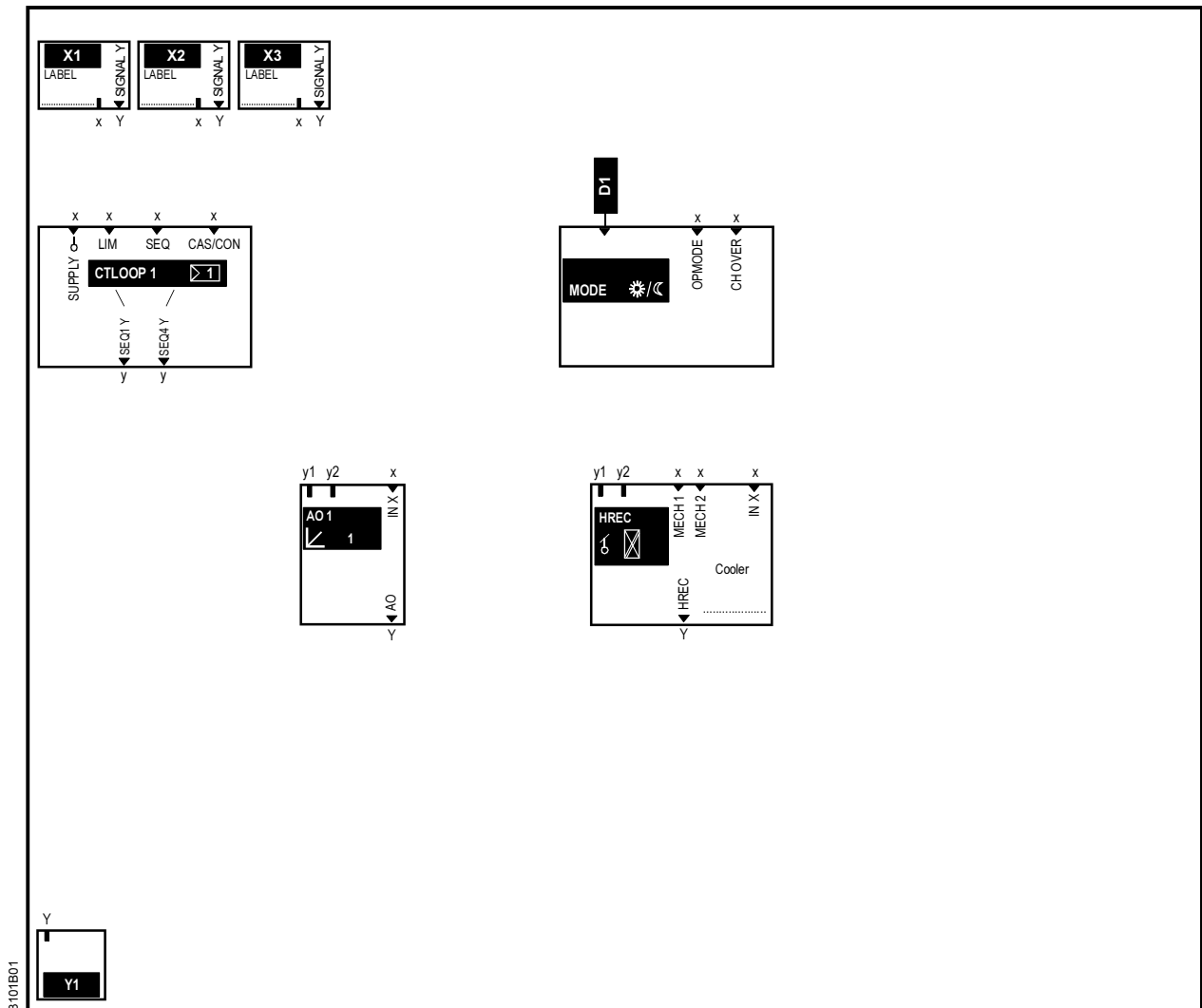

RLU210, basic type U

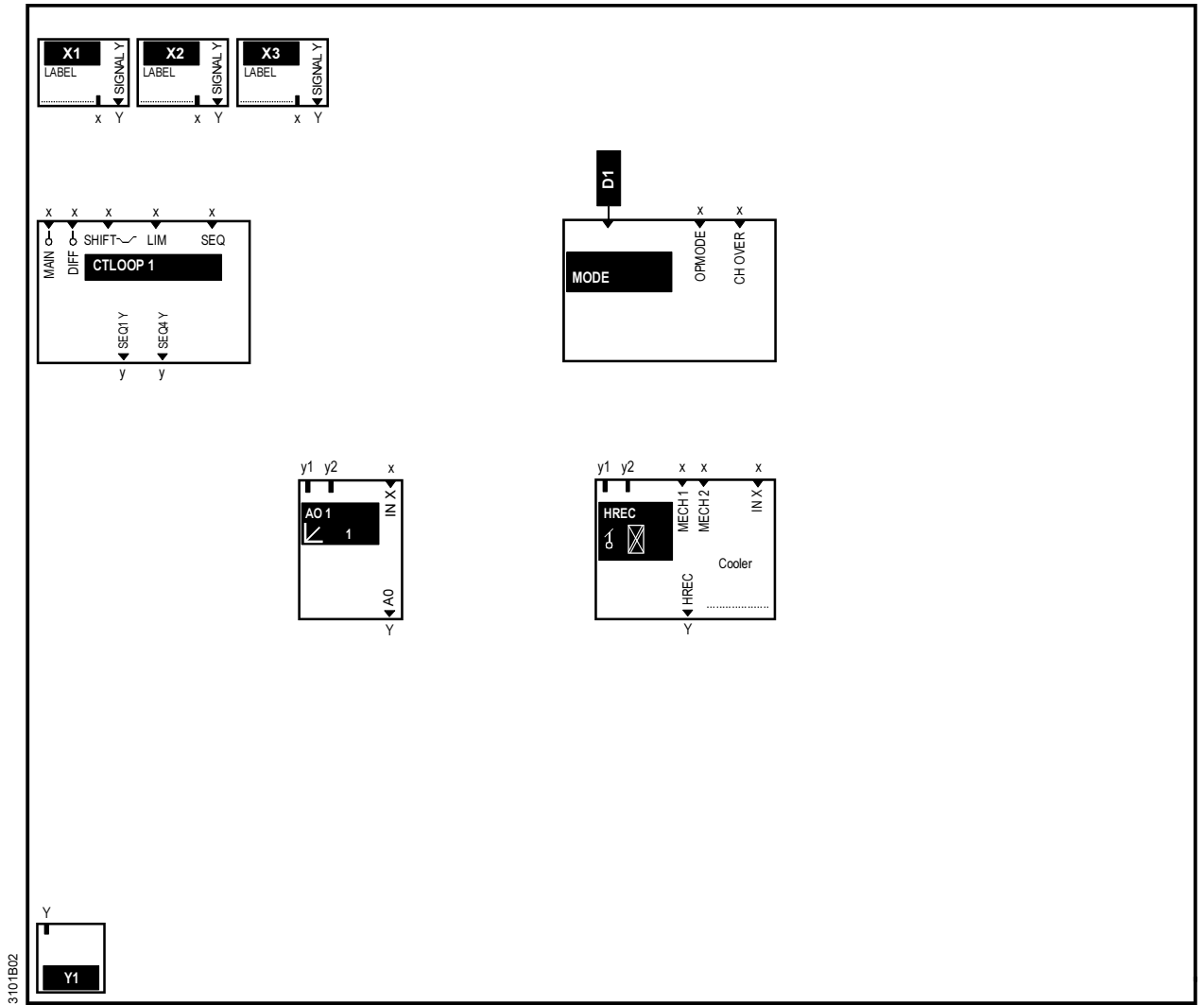

12.3.4 RLU222 configuration diagrams

RLU222, basic type A

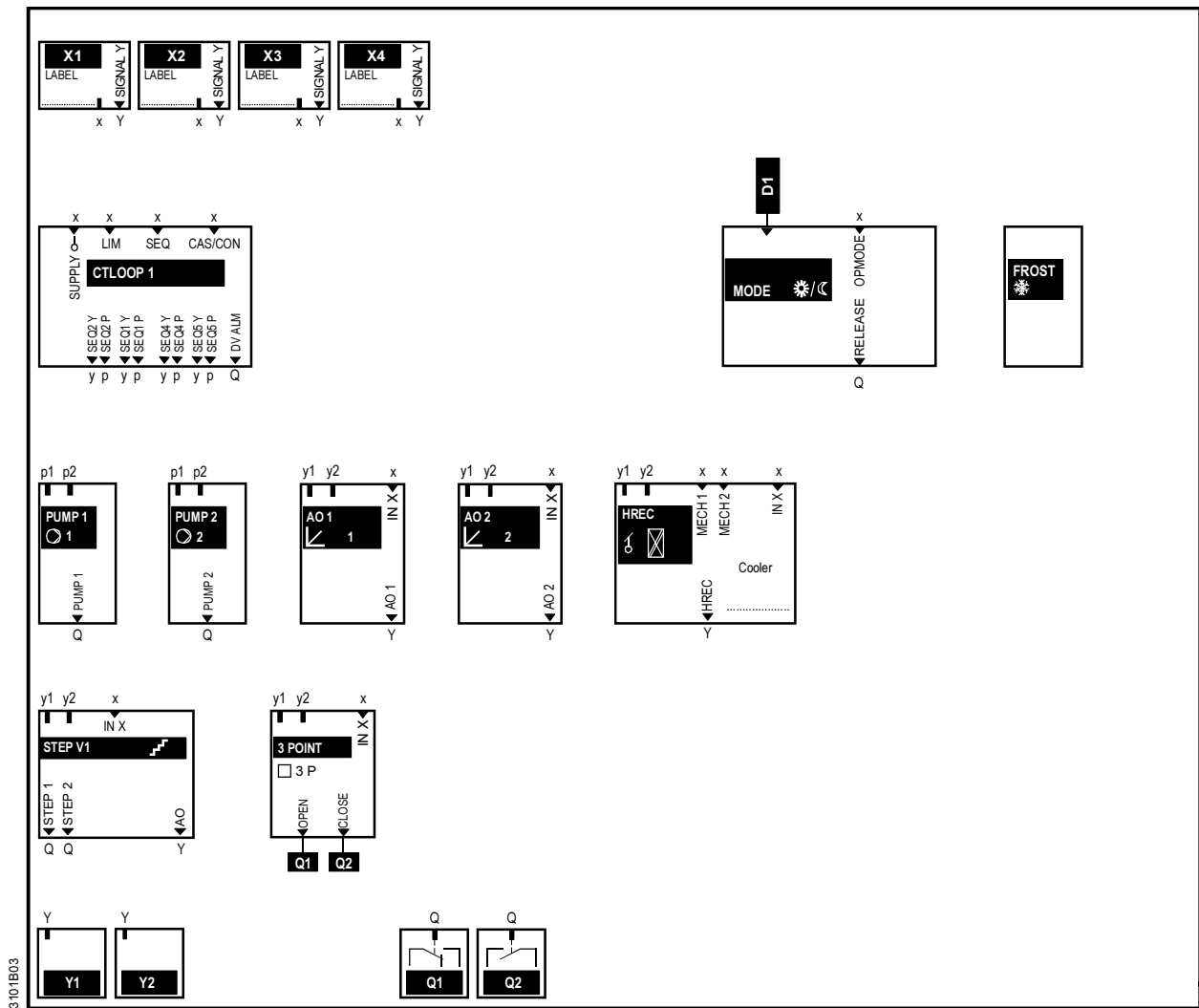

RLU222, basic type U

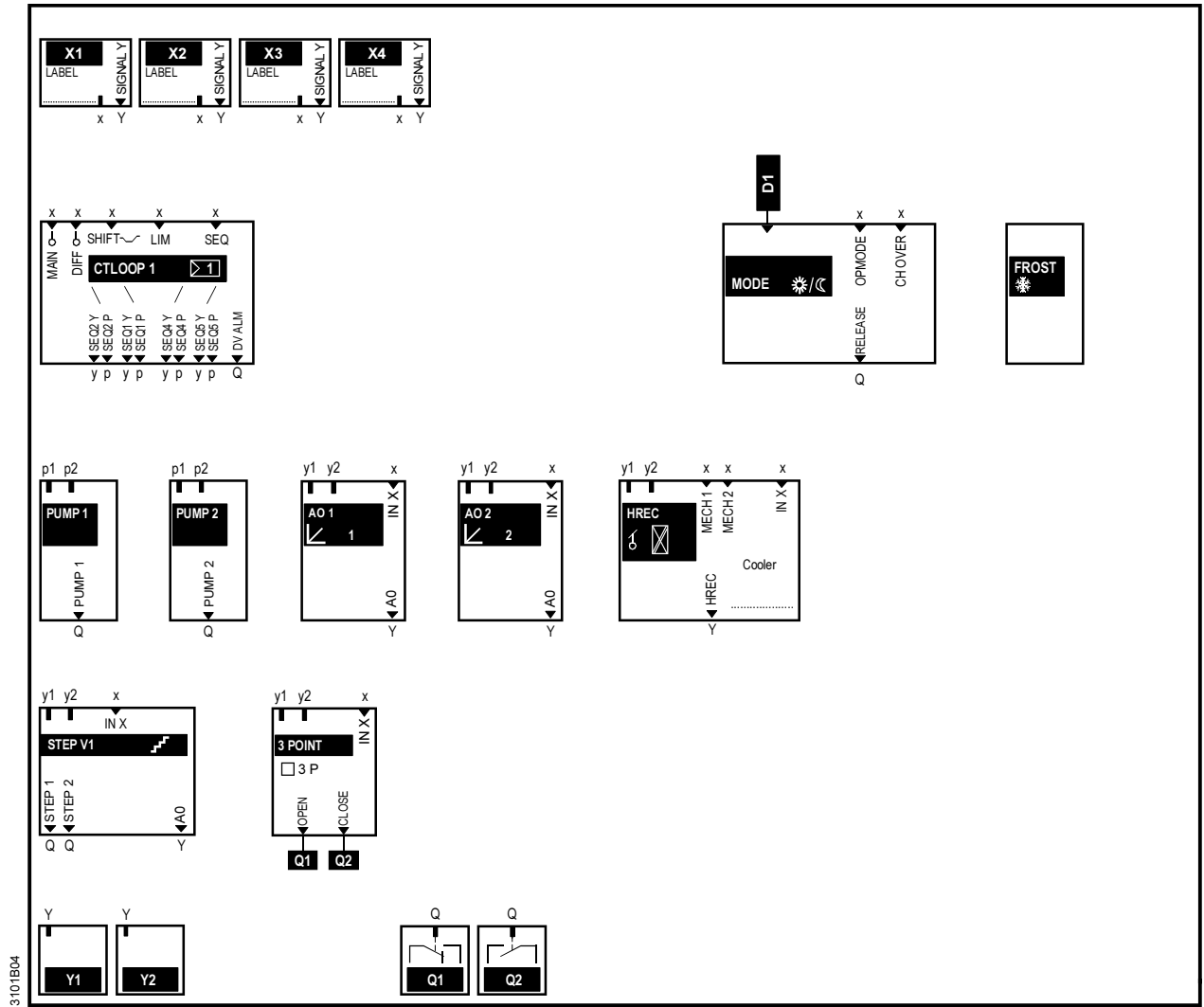

12.3.5 RLU232 configuration diagrams

RLU232, basic type A



RLU232, basic type U

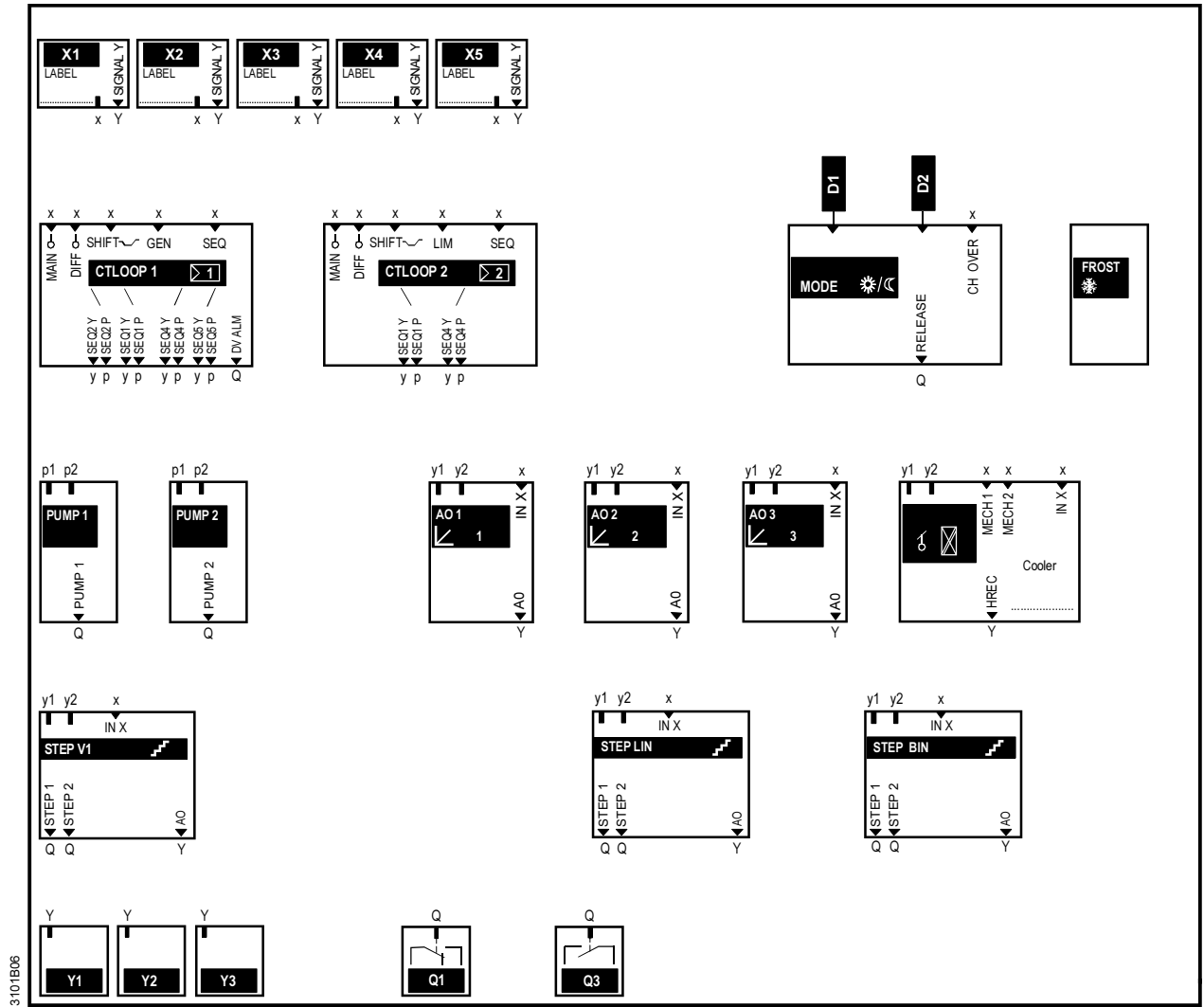

12.3.6 RLU236 configuration diagrams

RLU236, basic type A

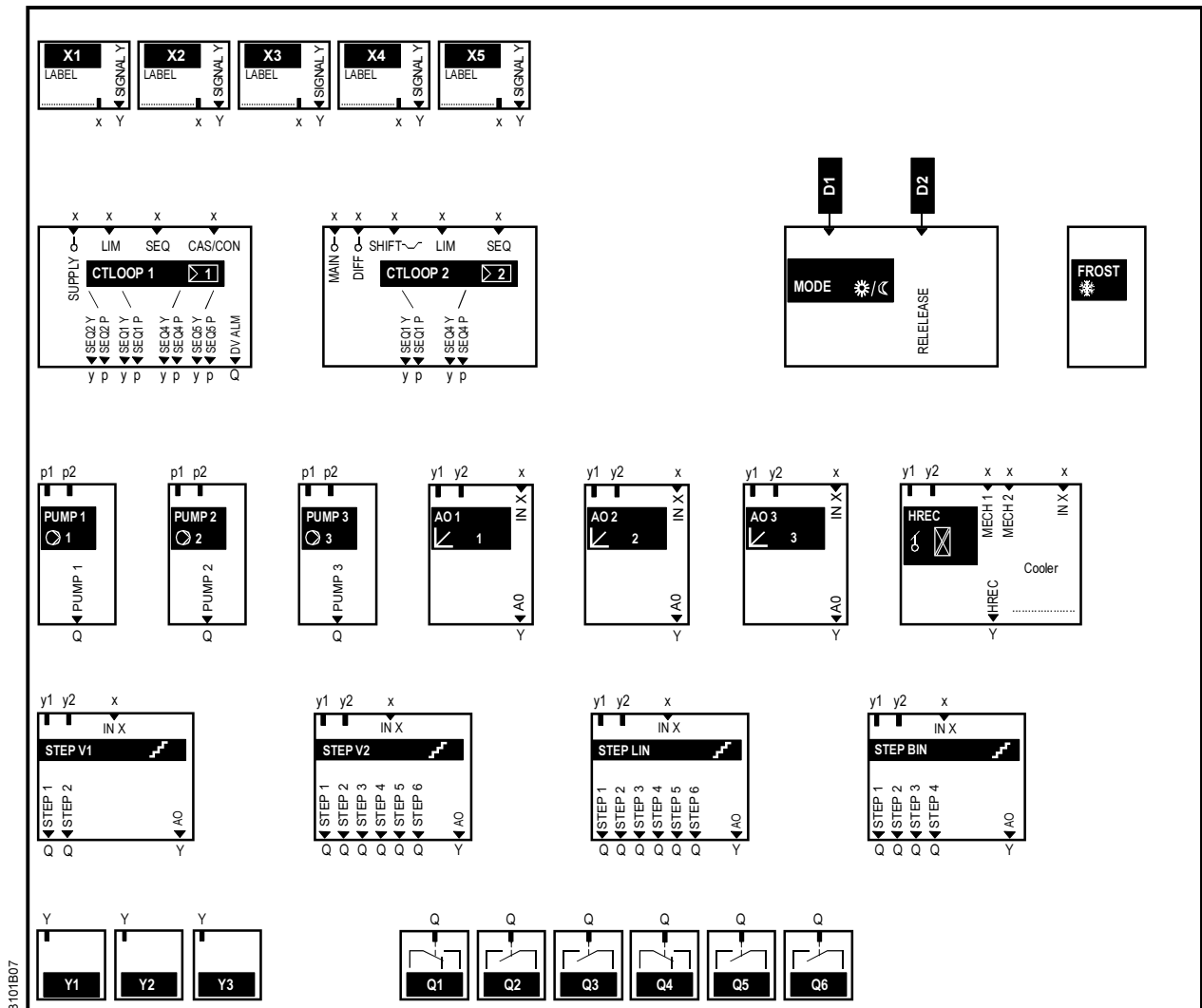

RLU236, basic type U

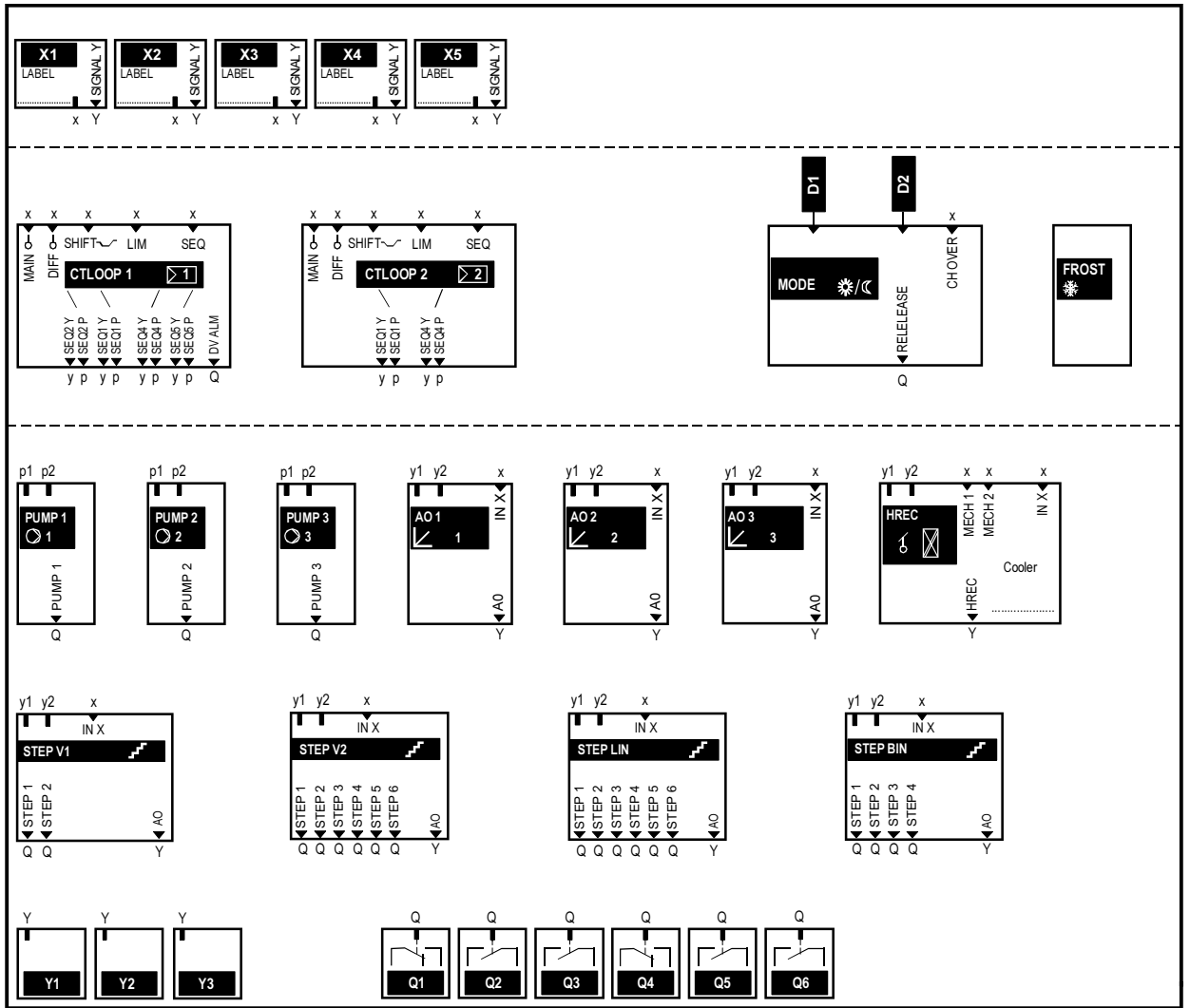

3101B08

13 Application examples

Introduction

The configurations and setting values for a number of typical, simple functions are listed in the following.

Note

If sufficient inputs and outputs are available, and the functions are switched on or off at the same time, you can also combine these functions.

13.1.1 Multiple sensor use

Purpose

LG-Ni 1000 passive temperature sensor (at X1)
You want to convert the signal to DC 0...10 V = 0...50 °C (at Y1) for further processing.

Configuration

CONF / X1 / LABEL	TEMP
CONF / X1 / SIGNALY	Y1

Setting values

PARA / X1 / TYPE	NI
PARA / X1 / MIN VAL	0 °C
PARA / X1 / MAX VAL	50 °C
PARA / X1 / CORR	0 K

13.1.2 Signal inversion

Purpose

You want to invert a DC 0...10 V signal (X1 to Y1).

Configuration

CONF / X1 / LABEL	%
CONF / X1 / SIGNALY	---
CONF / AO 1 / AO	Y1
CONF / AO 1 / IN X	X1

Setting values

PARA / D1 / NORMPOS	OPEN
PARA / AO 1 / MIN POS	0 %
PARA / AO 1 / MAX POS	100 %
PARA / AO 1 / INVERS	YES

13.1.3 Signal adaptation

Purpose

You want to adapt a DC 0...10 V signal (at X1) to DC 5...7.5 V (at Y1).

Configuration

CONF / X1 / LABEL	%
CONF / X1 / SIGNALY	---
CONF / AO 1 / AO	Y1
CONF / AO 1 / IN X	X1

Setting values

PARA / D1 / NORMPOS	OPEN
PARA / AO 1 / MIN POS	50 %
PARA / AO 1 / MAX POS	75 %
PARA / AO 1 / INVERS	NO

13.1.4 Step switch

Purpose You want to convert a DC 0...10 V signal (at X1) and an enable signal (at D1) to a binary step switch signal with 2 steps (at Q1+Q2).

Configuration

CONF / X1 / LABEL	%
CONF / X1 / SIGNALY	---
CONF / STEPBIN / STEP 1	Q1
CONF / STEPBIN / STEP2	Q2
CONF / STEPBIN / IN X	X1

Setting values

PARA / D1 / NORMPOS	CLSD
PARA / STEPBIN / OFFTIME	00.00

13.1.5 Modulating/two-position converter

Purpose Switch-on and switch-off command (at Q1) according to the resistance signal from an LG-Ni 1000 passive temperature sensor (at X1): ON at 28 °C, OFF at 25 °C.

Configuration

CONF / X1 / LABEL	TEMP
CONF / X1 / SIGNALY	---
CONF / STEP V1 / STEP 1	Q1
CONF / STEP V1 / IN X	X1

Setting values

PARA / D1 / NORMPOS	OPEN
PARA / X1 / TYPE	NI
PARA / X1 / MIN VAL	0 °C
PARA / X1 / MIN VAL	100 °C
PARA / X1 / CORR	0 K
PARA / STEP V1 / OFFTIME	00.00
PARA / STEP V1 / S1-ON	28 %
PARA / STEP V1 / S1-OFF	25 %

13.1.6 Signal Duplicator

Purpose You want to transmit a DC 0...10 V signal (at X1) as an active output (at Y1).

Configuration

CONF / X1 / LABEL	%
CONF / X1 / SIGNALY	Y1

Index

A	
Abbreviations used in this document.....	106
Access level, select.....	12
Alarm acknowledgement.....	103
Alarm list.....	102
Application examples	
Modulating/two-position converter.....	125
Multiple sensor use.....	124
Signal adaptation.....	124
Signal duplicator.....	125
Signal inversion.....	124
Step switch.....	125
B	
Basic configuration, choosing.....	16
Basic types A and U.....	20
Bedientexte (Kürzelliste).....	107
C	
Configuration	
Configuration diagrams.....	116
Explanation of the configuration principle.....	111
Function block overview.....	112
Control strategies.....	63
Controller (CTLOOP x).....	62
Controller configuration procedure.....	62
Controller with changeover	
Individual room control example.....	78
Primary controller.....	75
D	
Data point, term.....	11
Deviation message (DV ALM).....	93
Display symbols.....	10
E	
Electrical connections	
Connection rules.....	104
Connection terminals.....	105
F	
Fan release.....	22
Frost protection (FROST)	
2-stage frost protection examples.....	97
Acknowledgement.....	99
Connection diagrams.....	100
Description.....	95
Frost monitor example.....	96
H	
HREC	
Description.....	40
I	
Input identifiers.....	23
Inputs	
Analog X1...X5.....	24
Digital (D1, D2, X1...X5).....	28
Universal (X1...X5).....	23
L	
Limit control of individual sequences (SEQ).....	86
Limit control, general (LIM).....	84
Locking of sequences according to OT.....	89
M	
MECH	
Description.....	41
Possibilities.....	42, 45
Menu structure.....	13
O	
Operating level, change.....	11
Output, modulating (AO x).....	38
Outside temperature (OUTS).....	33
P	
Pump (PUMP x)	
Frost protection pump, example.....	37
Load-dependent recooling pump, example.....	37
Pumpe (PUMP x)	
Description.....	35
R	
Remote setpoint, absolute (REM).....	29
Remote setpoint, relative (REL).....	31
Room mode selection.....	20
Room temperature (ROOM):.....	34
Room temperature control.....	65
Room/supply air temperature cascade controller.....	66
S	
Sequence controller	
Control parameters.....	81
Load outputs.....	80
Pump outputs.....	81
Sequence controllers	
Output assignments.....	79
Setpoint shift, universal.....	91
Settings, general.....	19
Step switch	
Binary (STEPBIN).....	56
Linear (STEPLIN).....	52
Variable (STEP Vx).....	49
Summer/winter compensation.....	90
Supply air temperature control.....	70

T

Three-position output (3-POINT) 60

U

Universal controller

Chilled ceiling example 72

Description 72

Solar plant example 72

Siemens Building Technologies AG
HVAC Products
Gubelstrasse 22
CH-6301 Zug
Tel. +41 41-724 24 24
Fax +41 41-724 35 22
www.landisstaefa.com

© 2004 Siemens Building Technologies AG
Subject to alteration